



# Hot Rolled and Structural Steel Products

Ninth Edition





# Contents

---

**Foreword and Introduction** **2**

---

**Commitment to Quality**

Test Certificates – EzyCommerce and ACRS	3
--	---

---

**Availability**

Structural Steel Sections	5
Merchant Bar Sections	7

---

**Dimensions and Design Information**

Universal Beams	10
Universal Columns	12
Tapered Flange Beams	14
Parallel Flange Channels	15
Universal Bearing Piles	16
Equal Angles	17
Unequal Angles	20

---

**Tolerances**

Rounds and Squares	23
Flats	23
Universal Beams	24
Universal Columns	24
Parallel Flange Channels	25
Tapered Flange Beams	25
Universal Bearing Piles	25
Equal Angles	26
Unequal Angles	27

---

**Straightness**

Universal Sections	28
Non-universal Sections	28

---

**Standard Specifications**

Structural Steel Sections	29
Merchant Bar Sections	30

---

**Customer Technical Service** **31**

---

# Foreword

This edition of Liberty Steel's Hot Rolled and Structural Steel Product Catalogue incorporates the following changes from the previous edition.

- The depths and widths of Universal Beams (UBs) and Columns (UCs) were previously provided to three significant figures. For consistency with AS/NZS 3679.1 *Structural Steel – Hot rolled bars and sections*, these measurements are now provided to one decimal place. The dimensions for UBs and UCs were converted from imperial to metric units of measure in the mid 1970s and resulted in dimensions that were not whole millimetres. Until this edition they were rounded to three significant figures. The other sections in the Catalogue are metric and therefore in whole millimetres. The section properties for all sections in this version and the previous versions have used depths and widths correct to one decimal place to calculate the tabulated values presented to three significant figures. These values are unchanged from the previous edition.
- The inclusion of tolerance tables for each of the products listed. These values are consistent with AS/NZS 3679.1.
- The inclusion of tables providing the allowable camber and sweep of sections consistent with AS/NZS 3679.1.

## Introduction

Liberty Steel owns facilities which have a long and significant presence in the Australian steel industry. These facilities which produce steel and finished steel products, date back to the establishment of steelmaking in Newcastle in 1915 and continues to the present day.

Liberty Steel's major manufacturing facilities for hot rolled products are located in Whyalla, South Australia; in Melbourne, Victoria and in Newcastle and western Sydney, New South Wales. Together they are considered Australia's premier manufacturer of steel long products. These products include structural sections, rail, sleepers, rod, bar, and wire.

This catalogue, which demonstrates Liberty Steel's ongoing commitment to the Australian construction and manufacturing industry, has been produced to provide general information on a range of hot rolled structural steel products.

# Commitment to Quality

Liberty Steel supplies products that are compliant to the relevant Australian Standards or its own high quality standards. Liberty Steel's aim is to supply a consistent high quality product which delivers benefits to our customers by minimising variation and reducing waste.

The quality of products is constantly checked in NATA accredited testing laboratories, by skilled technical staff using proven equipment. Strict metallurgical control is maintained, from receipt of raw materials to despatch of the finished product. Products are rigorously tested and certified, with test certificates providing assurance that Liberty Steel sections meet all required specifications. These are made available free of charge via our EzyCommerce® website.

At its manufacturing sites Liberty Steel has third party accreditation to Quality Management System ISO 9001 and Environmental Management System ISO 14001.

## Test Certificates – EzyCommerce

NATA accredited test certificates are available for all AS/NZS 3679.1 products. The Steel Structures Design Standard – AS4100, acknowledges these certificates provide designers and certifiers with sufficient evidence that they are acceptable steels for use in designs to AS4100. Our test certificates also comply with EN10204 Type 3.1.

Fabricators can ensure they receive a copy of the relevant certificate covering the steel ordered and delivered by requesting them at the time of order. The certificates can be provided manually, electronically or customers can access these via Liberty Steel's EzyCommerce® website at <https://ezycommerce.libertygfg.com>

All distributors of Liberty Steel AS/NZS 3679.1 products have access to certificates via EzyCommerce® – this is a free service that offers the ability to access and retrieve this information anytime.

**Access to EzyCommerce® Online is free to approved customers of Liberty Steel – all you need is a login name and password – please refer to [www/libertygfg.com/steel/ezycommerce](http://www.libertygfg.com/steel/ezycommerce) for more information on obtaining access to the website.**



### For more information:

Ezycommerce, <https://libertygfg.com/steel/ezycommerce>

## ACRS - Third Party Certification

In addition to our quality systems and NATA endorsed laboratories, Liberty Steel's range of AS/NZS 3679.1 hot rolled products are all produced at mills with ACRS certification.

Copies of our ACRS accreditation can be viewed at the Liberty Steel website: [www.libertygfg.com](http://www.libertygfg.com)

### For more information:

Liberty Steel website: [www.libertygfg.com](http://www.libertygfg.com)

ACRS: [www.steelcertification.com](http://www.steelcertification.com)





# Commitment to Quality

## Test Certificate sample



### TEST CERTIFICATE

Page 1 of 2  
**Certificate No.: W971841**  
 Transmission Date: 28/11/17

Customer:	Supplier: OneSteel Manufacturing Pty Limited Whyalla, SA - 5600, Australia A.B.N. 42 004 651 325
Ship To:	Sales Order No: B7093 Printed on: 28/11/2018

 <p>Accredited for compliance with ISO/IEC 17025 - Testing. This document shall not be reproduced except in full.</p>	Sampling undertaken by OneSteel Whyalla 15352 Approved Signatory - P. Rawnsley Chemical results as identified are from Bureau Veritas Minerals Pty Ltd, Whyalla 0834 Approved Signatory - K. Barsby Mechanical results as identified are from Bureau Veritas Minerals Pty Ltd, Whyalla 0794 Approved Signatory - I. Harrison
--	---

STEELMAKING: Basic Oxygen - Slab Cast  
 SPECIFICATION: **AS/NZS3679.1-300PLUS/S0**  
 PRODUCT: **310UB40.4**

INSPECTION: Supplier  
 CERTIFICATION: Supplier

#### ITEMS COVERED BY THIS TEST CERTIFICATE

Item No	Heat No	Customer Order	Length
2260C	571984	7505648987	10.500
2260C	571985	7505648987	10.500
2260C	571986	7505648987	10.500
2289C	571973	7505649607	18.000
2289C	571984	7505649607	18.000

#### CHEMICAL ANALYSIS

Percentage of element by mass (L=Cast, P=Product, -S=Soluble, -T=Total, CF=Chemical Formula, n=Min, x=Max)

Item No	Heat / Unit No	NATA Lab	L/P	C	P	Mn	Si	S	Ni	Cr	Mo	Cu	Sn	Al
2260C	571984	0834	L	.188	.018	1.32	.150	.006	.008	.022	.005	.008	.002	.012
2260C	571985	0834	L	.184	.016	1.33	.140	.008	.007	.022	.005	.008	.002	.022
2260C	571986	0834	L	.188	.013	1.34	.130	.007	.007	.022	.005	.008	.001	.023
2289C	571973	0834	L	.157	.016	1.53	.150	.010	.008	.024	.006	.009	.002	.022
2289C	571984	0834	L	.188	.018	1.32	.150	.006	.008	.022	.005	.008	.002	.012

Item No	Heat / Unit No	NATA Lab	L/P	Nb	Ti	B	V	N	Ca	Zr	CF1
2260C	571984	0834	L	.003	.001	.0005	.002	.0042	.0001	.002	.41
2260C	571985	0834	L	.003	.001	.0005	.002	.0050	.0001	.002	.41
2260C	571986	0834	L	.003	.001	.0006	.002	.0044	.0001	.002	.42
2289C	571973	0834	L	.004	.001	.0005	.002	.0060	.0001	.003	.42
2289C	571984	0834	L	.003	.001	.0005	.002	.0042	.0001	.002	.41

$$CF1 = C + Mn/6 + (Cr + Mo + V)/5 + (Ni + Cu)/15$$

#### MECHANICAL TESTING

##### Tensile

Item No	Heat No	Tested Unit	NATA Lab	Test Report	ReH MPa	Rm MPa	ELONGN %
2260C	571984	571984	0794	57196	380	520	37
2260C	571984	571984	0794	57196	365	500	36
2260C	571985	571985	0794	57197	350	500	36
2260C	571985	571985	0794	57197	350	490	36
2260C	571986	571986	0794	57197	355	490	36
2260C	571986	571986	0794	57197	355	500	39
2289C	571973	571973	0794	57196	360	500	38
2289C	571973	571973	0794	57196	345	490	38
2289C	571973	571973	0794	57196	360	510	34
2289C	571984	571984	0794	57196	380	520	37
2289C	571984	571984	0794	57196	365	500	36

Yield Strength - determined in accordance with requirements of nominated product standard

# Availability

## Structural Steel Sections

### Hot Rolled Products

Hot Rolled Structural Steel Sections produced by Liberty Steel are manufactured in accordance with the requirements of Australian Standard AS/NZS 3679.1 Structural steel – hot rolled bars and sections.

#### Grade Availability

300PLUS® Steel is the standard product manufactured by Liberty Steel for hot rolled Structural Steel Sections for Australia.

300PLUS® Steel for hot rolled products is produced to exceed the minimum requirements of AS/NZS 3679.1 grade 300.

For further information contact Liberty Steel Sales.

The following AS/NZS 3679.1 grades are also available by enquiry and will depend on the section and quantity required.

**Table 1: Additional Grades Available**

#### Additional Grades Available

300PLUS® L0 – Exceeds the requirements of AS/NZS 3679.1 – 300L0

300PLUS® L15 – Exceeds the requirements of AS/NZS 3679.1 – 300L15

AS/NZS 3679.1 – 350

AS/NZS 3679.1 – 350L0

AS/NZS 3679.1 – 350L15

#### Length Availability

The majority of Structural Steel Sections produced by Liberty Steel are available in standard length and bundle configurations.

We would recommend that attention be given to the standard lengths produced by Liberty Steel as they are more readily available than other lengths. Table 2 (page 6) indicates the standard lengths produced by Liberty Steel in Structural Steel Sections. For other lengths (including those in excess of 18 metres) please contact Liberty Steel Sales for further details.

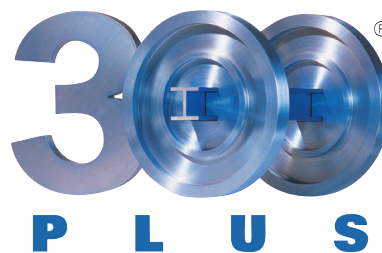

# Availability

Table 2 Standard Lengths

Section	Length (m)										
	6.0	7.5	9.0	10.5	12.0	13.5	14.0	15.0	16.5	18.0	20.0*
<b>Universal Beams</b>											
610 UB, 530 UB, 460 UB, 410 UB, 360 UB			●	●	●	●		●	●	●	●
310 UB 46.2, 40.4			●	●	●	●		●	●	●	●
310 UB 32.0			●	●	●	●		●		●	
250 UB			●	●	●	●		●	●	●	
200 UB 29.8, 25.4, 22.3			●	●	●	●		●	●	●	
200 UB 18.2			●	●	●	●		●			
180 UB, 150 UB			●	●	●	●		●	●		
<b>Universal Columns</b>											
310 UC 158, 137, 118			●	●	●	●		●	●	●	
310 UC 96.8			●	●	●	●		●	●	●	●
250 UC			●	●	●	●		●	●	●	●
200 UC, 150 UC			●	●	●	●		●	●	●	
100 UC			●		●			●			
<b>Tapered Flange Beams</b>											
125 TFB, 100 TFB		●	●		●		●	●			
<b>Parallel Flange Channels</b>											
380 PFC, 300 PFC, 250 PFC, 230 PFC, 200 PFC, 180 PFC			●	●	●	●		●	●	●	
150 PFC			●	●	●	●		●			
125 PFC, 100 PFC, 75 PFC	●		●		●						
<b>Universal Bearing Piles</b>											
310 UBP, 200 UBP											By enquiry
<b>Equal Angles</b>											
200 EA, 150 EA, 125 EA			●	●	●	●		●			
100 EA, 90 EA **	+	+	●		●						
75 EA, 65 EA, 55 EA, 50 EA **	+	+	●		+						
45 EA, 40EA, 30 EA, 25 EA	+	+	+		+						
<b>Unequal Angles</b>											
150 x 100 UA, 150 x 90 UA			●	●	●	●		●			
125 x 75 UA, 100 x 75 UA	+	+	+		+						
75 x 50 UA, 65 x 50 UA	+	+	+		+						

● The Section/Length combination is available in Standard Bundle configurations.

\* By enquiry – delivery to capital cities only.

\*\* Certain thicknesses may not be available in both lengths. Confirm availability with Liberty Steel.

+ By enquiry.



# Availability

## Merchant Bar Sections

### Rounds, Squares and Flats

#### Availability

Merchant bar rounds, squares and flats are available in a variety of steel grades and sizes.

Due to process limitations not all grades are available in all sizes. For new applications we recommend you confirm product availability with a Liberty Steel Sales Office at an early stage of design. Other specifications and sizes may also be available on enquiry.

#### Specifications

Merchant bar sections are available in the following standards:

- 300PLUS® and AS/NZS 3679.1 – Structural Steel – Hot rolled bars and sections.
- AS 1442 – Carbon Steels and Carbon Manganese Steels – Hot rolled bars and semifinished products.
- AS 1444 – Wrought Alloy Steels Standard, Hardenability (H) Series and Hardened and Tempered to Designated Mechanical Properties.
- AS 1447 – Hot-rolled spring steels.
- Liberty Steel grades (based on AISI-SAE nomenclature).

**Table 3 Rounds – Size Availability and Mass**

Diameter (mm)	Mass (kg/m)
10	0.616
12	0.887
13	1.04
14	1.21
15	1.39
16	1.58
17	1.78
18	1.99
19	2.23
20	2.46
22	2.98
24	3.55
27	4.49
30	5.55
33	6.71
36	7.99
39	9.38
42	10.9
45	12.5
48	14.2
50	15.4
56	19.3
60	22.2
65	26.0
75	34.7
90	49.9

Standard Length: 6 metres

**Table 4 Squares – Size Availability and Mass**

Thickness (mm)	Mass (kg/m)
10*	0.790
12	1.13
16	2.01
20	3.14
25	4.91
40	12.5

Standard Length: 6 metres

\* Confirm availability.

# Availability

Table 5 Flats – Size Availability and Mass (kg/m)

Width (mm)	Thickness (mm)							
	5	6	8	10	12	16	20	25
20				1.57				
25	0.981	1.18	1.57	1.96	2.36			
32	1.26	1.51	2.01	2.51	3.01			
40	1.57	1.88	2.51	3.14	3.77	5.02	6.28	
50	1.96	2.36	3.14	3.93	4.71	6.28	7.85	9.81
65	2.55	3.06	4.08	5.10	6.12	8.16	10.2	
75	2.94	3.53	4.71	5.89	7.07	9.42	11.8	14.7
90		4.24	5.65	7.07	8.48			
100	3.93	4.71	6.28	7.85	9.42	12.6	15.7	19.6
110				8.64				
130			8.16	10.2	12.2	16.3	20.4	25.5
150			9.42	11.8	14.1	18.8	23.6	29.4

Standard Length: 6 metres



# Availability

**Table 6 Merchant Bar Sections – Regular Grade**

Steel Type	Standard	Grades Available
Structural Steels	Liberty Steel AS/NZS 3679.1	300PLUS® 350
Carbon and Carbon-Manganese Steels	AS 1442	1016 1022 1045
Spring Steels	AS 1447	XK5160S XK9258S XK9261S
Liberty Steel Grades	Liberty Steel	X4K92M61S

**Note**

Liberty Steel 300PLUS® exceeds the requirements of AS/NZS 3679.1 Grade 300. Grade availability can vary with section.

**Rods and Light Billets**

Rods and light billets are available in a wide range of Liberty Steel grades, and selected grades from AS 1442, AS 1444 and AS 1447 specifications.

These sections are not available in structural grades 300PLUS® or 350 grade.

Due to process limitations not all grades are available in all sizes. Confirm product availability with a Liberty Steel Sales Office at an early stage of design.

**Table 7 Rods – Size Availability**

Diameter (mm)										
5.5	6.5	7.0	8.0	9.0	10.0	11.2	12.5	13.0	14.0	
15.0	16.0	17.0	18.0							

**Table 8 Light Billets – Size Availability**

Sizes Available (mm x mm)	
	45 x 45
	50 x 50
	63 x 63
	75 x 75

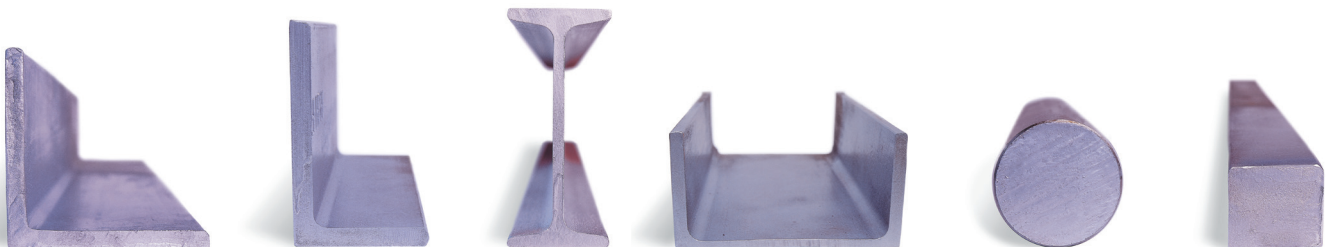

# Universal Beams

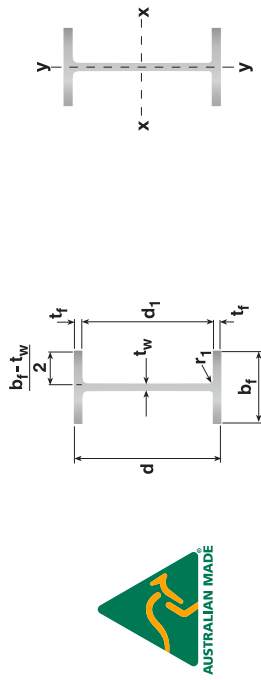
**Table 9 Universal Beams – Dimensions and Properties**

Designation	Depth of Section		Flange Width	Flange Thickness	Web Thickness	Root Radius	Depth Between Flanges	Gross Area of Cross Section		About x-axis			About y-axis			Torsion Constant	Warping Constant	Designation
	d	d <sub>1</sub>						A <sub>b</sub>	A <sub>w</sub>	I <sub>x</sub>	Z <sub>x</sub>	S <sub>x</sub>	r <sub>x</sub>	I <sub>y</sub>	Z <sub>y</sub>			
kg/m	mm	mm	mm	mm	mm	mm	mm	mm <sup>2</sup>	mm <sup>2</sup>	10 <sup>8</sup> mm <sup>4</sup>	10 <sup>3</sup> mm <sup>3</sup>	10 <sup>3</sup> mm <sup>3</sup>	10 <sup>6</sup> mm <sup>4</sup>	mm	mm	10 <sup>3</sup> mm <sup>3</sup>	10 <sup>8</sup> mm <sup>6</sup>	
610UB125	611.6	229.0	19.6	11.9	14.0	572.4	48.1	5.54	16000	986	3230	3680	343	343	49.6	1560	3450	610UB125
113	607.0	228.0	17.3	11.2	14.0	572.4	51.1	6.27	14500	875	2880	3290	300	300	46.9	1140	2980	113
101	602.0	228.0	14.8	10.6	14.0	572.4	54.0	7.34	13000	761	2530	2900	242	257	40.2	790	2530	101
530UB92.4	533.0	209.0	15.6	10.2	14.0	501.8	49.2	6.37	11800	554	2080	2370	228	228	35.5	775	1590	530UB92.4
82.0	528.2	209.0	13.2	9.6	14.0	501.8	52.3	7.55	10500	477	1810	2070	193	193	30.1	526	1330	82.0
460UB82.1	460.4	191.0	16.0	9.9	11.4	428.4	43.3	5.66	10500	372	1610	1840	188	186	30.3	701	919	460UB82.1
74.6	457.4	190.0	14.5	9.1	11.4	428.4	47.1	6.24	9520	335	1460	1660	188	175	27.1	418	530	74.6
67.1	453.8	190.0	12.7	8.5	11.4	428.4	50.4	7.15	8580	296	1300	1480	186	14.5	23.8	378	708	67.1
410UB59.7	406.4	178.0	12.8	7.8	11.4	380.8	48.8	6.65	7640	216	1060	1200	168	12.1	13.5	209	337	410UB59.7
53.7	402.6	178.0	10.9	7.6	11.4	380.8	50.1	7.82	6890	188	933	1060	165	10.3	11.5	179	234	53.7
360UB56.7	358.6	172.0	13.0	8.0	11.4	332.6	41.6	6.31	7240	161	899	1010	149	11.0	12.8	198	338	360UB56.7
50.7	355.6	171.0	11.5	7.3	11.4	332.6	45.6	7.12	6470	142	798	897	148	9.60	11.2	173	241	50.7
44.7	352.0	171.0	9.7	6.9	11.4	332.6	48.2	8.46	5720	121	689	777	146	8.10	9.47	146	161	44.7
310UB46.2	307.2	166.0	11.8	6.7	11.4	283.6	42.3	6.75	5930	100	654	729	130	9.01	10.9	166	233	310UB46.2
40.4	304.0	165.0	10.2	6.1	11.4	283.6	46.5	7.79	5210	86.4	569	633	129	7.65	9.27	142	157	40.4
32.0	298.0	149.0	8.0	5.5	13.0	282.0	51.3	8.97	4080	63.2	424	475	124	4.42	5.93	91.8	86.5	32.0
250UB37.3	256.2	146.0	10.9	6.4	8.9	234.4	36.6	6.40	4750	55.7	435	486	108	5.66	7.75	119	158	250UB37.3
31.4	251.6	146.0	8.6	6.1	8.9	234.4	38.4	8.13	4010	44.5	354	397	105	4.47	6.12	94.2	65.9	31.4
25.7	248.0	124.0	8.0	5.0	12.0	232.0	46.4	7.44	3270	35.4	285	319	104	2.55	4.11	63.6	27.9	25.7
200UB29.8	207.0	134.0	9.6	6.3	8.9	187.8	29.8	6.65	3820	29.1	281	316	87.3	3.86	5.75	88.4	105	200UB29.8
25.4	203.2	133.0	7.8	5.8	8.9	187.6	32.3	8.15	3230	23.6	232	260	62.7	3.06	4.61	70.9	30.8	25.4
22.3	201.6	133.0	7.0	5.0	8.9	187.6	37.5	9.14	2870	21.0	208	231	85.4	2.75	4.13	63.4	26.0	22.3
18.2	198.0	99.0	7.0	4.5	11.0	184.0	40.9	6.75	2320	15.8	160	180	180	1.14	2.30	35.7	22.1	18.2
180UB22.2	179.0	90.0	10.0	6.0	8.9	159.0	26.5	4.20	2820	15.3	171	195	73.6	1.22	2.71	42.3	20.8	180UB22.2
18.1	175.0	90.0	8.0	5.0	8.9	159.0	31.8	5.31	2300	12.1	139	157	72.6	0.975	2.17	33.7	20.6	18.1
16.1	173.0	90.0	7.0	4.5	8.9	159.0	35.3	6.11	2040	10.6	123	138	72.0	0.853	1.90	29.4	20.4	16.1
150UB18.0	155.0	75.0	9.5	6.0	8.0	136.0	22.7	3.63	2300	9.05	117	135	62.8	0.672	1.79	28.2	17.1	150UB18.0
14.0	150.0	75.0	7.0	5.0	8.0	136.0	27.2	5.00	1780	6.66	88.8	102	61.1	0.495	1.32	20.8	16.6	14.0

# Universal Beams

## Table 10 Universal Beams – Properties for Assessing Section Capacity

Designation	Yield Stress			Form Factor			About x-axis			About y-axis			Designation			
	Flange $f_y$ MPa	Web $f_y$ MPa	MPa	$k_f$	Compactness	$Z_{xx}$ $10^3\text{mm}^3$	Compactness	$Z_{yy}$ $10^3\text{mm}^3$	Flange $f_y$ MPa	Web $f_y$ MPa	MPa	$k_f$		Compactness	$Z_{xx}$ $10^3\text{mm}^3$	Compactness
<b>300PLUS® *</b>																
610 UB 125	280	300	300	0.950	C	3680	C	515	340	340	340	0.916	C	3680	C	515
113	280	300	300	0.926	C	3290	C	451	340	340	340	0.891	C	3290	C	451
101	300	320	320	0.888	C	2900	C	386	340	360	360	0.867	C	2900	C	386
530 UB 92.4	300	320	320	0.928	C	2370	C	342	340	360	360	0.907	C	2370	C	342
82.0	300	320	320	0.902	C	2070	C	289	340	360	360	0.880	C	2070	C	289
460 UB 82.1	300	320	320	0.979	C	1840	C	292	340	360	360	0.956	C	1840	C	292
74.6	300	320	320	0.948	C	1660	C	262	340	360	360	0.926	C	1660	C	262
67.1	300	320	320	0.922	C	1480	C	230	340	360	360	0.901	C	1480	C	230
410 UB 59.7	300	320	320	0.938	C	1200	C	203	340	360	360	0.918	C	1200	C	203
53.7	320	320	320	0.913	C	1060	C	173	360	360	360	0.894	N	1050	N	172
360 UB 56.7	300	320	320	0.996	C	1010	C	193	340	360	360	0.974	C	1010	C	193
50.7	300	320	320	0.963	C	897	C	168	340	360	360	0.943	C	897	C	168
44.7	320	320	320	0.930	N	770	N	140	360	360	360	0.911	N	762	N	139
310 UB 46.2	300	320	320	0.991	C	729	C	163	340	360	360	0.972	C	729	C	163
40.4	320	320	320	0.952	C	633	C	139	360	360	360	0.936	N	629	N	138
32.0	320	320	320	0.915	N	467	N	86.9	360	360	360	0.898	N	462	N	85.7
250 UB 37.3	320	320	320	1.00	C	486	C	116	360	360	360	1.00	C	486	C	116
31.4	320	320	320	1.00	N	395	N	91.4	360	360	360	0.991	N	392	N	90.3
25.7	320	320	320	0.949	C	319	C	61.7	360	360	360	0.932	C	319	C	61.7
200 UB 29.8	320	320	320	1.00	C	316	C	86.3	360	360	360	1.00	C	316	C	86.3
25.4	320	320	320	1.00	N	259	N	68.8	360	360	360	1.00	N	257	N	68.0
22.3	320	320	320	1.00	N	227	N	60.3	360	360	360	1.00	N	225	N	59.4
18.2	320	320	320	0.990	C	180	C	34.4	360	360	360	0.970	C	180	C	34.4
180 UB 22.2	320	320	320	1.00	C	195	C	40.7	360	360	360	1.00	C	195	C	40.7
18.1	320	320	320	1.00	C	157	C	32.5	360	360	360	1.00	C	157	C	32.5
16.1	320	320	320	1.00	C	138	C	28.4	360	360	360	1.00	C	138	C	28.4
150 UB 18.0	320	320	320	1.00	C	135	C	26.9	360	360	360	1.00	C	135	C	26.9
14.0	320	320	320	1.00	C	102	C	19.8	360	360	360	1.00	C	102	C	19.8

\* 300PLUS® replaced Grade 250 as the base grade for these sections in 1994.

300PLUS® hot rolled sections are produced to exceed the minimum requirements of AS/NZS 3679.1-300.

### Notes

1. For 300PLUS® sections the tensile strength ( $f_t$ ) is 440 MPa.
2. For Grade 350 sections the tensile strength ( $f_t$ ) is 480 MPa.
3. C: Compact Section; N: Non-compact Section; S: Slender Section.

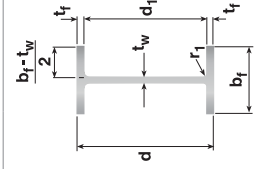

## Universal Columns

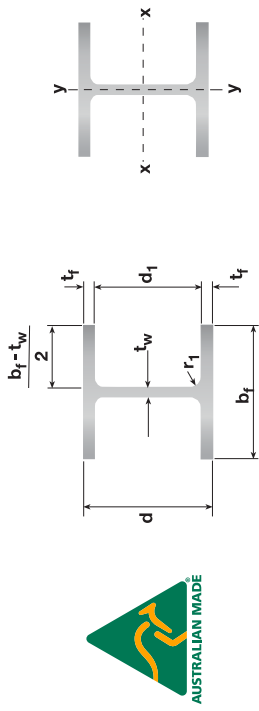

**Table 11 Universal Columns – Dimensions and Properties**

Designation	Depth of Section	Flange		Web Thickness	Root Radius	Depth Between Flanges		$d_1$	$(b_f t_w)$		Gross Area of Cross Section			About x-axis			About y-axis			Torsion Constant	Warping Constant	Designation
		Width	Thickness			$t_f$	$t_w$		$r_1$	$d_1$	$2t_f$	$A_g$	$I_x$	$Z_x$	$S_x$	$r_x$	$I_y$	$Z_y$	$S_y$			
kg/m	mm	mm	mm	mm	mm	mm	mm	mm	mm <sup>2</sup>	10 <sup>6</sup> mm <sup>4</sup>	10 <sup>3</sup> mm <sup>3</sup>	mm	10 <sup>6</sup> mm <sup>4</sup>	10 <sup>3</sup> mm <sup>3</sup>	10 <sup>3</sup> mm <sup>3</sup>	mm	10 <sup>3</sup> mm <sup>4</sup>	10 <sup>3</sup> mm <sup>3</sup>	mm	10 <sup>3</sup> mm <sup>4</sup>	10 <sup>9</sup> mm <sup>6</sup>	
310 UC 158	327.2	311.0	25.0	15.7	16.5	277.2	17.7	5.91	20100	388	2370	2680	139	125	807	1230	78.9	3810	2860	310 UC 158		
	137	320.6	309.0	21.7	13.8	277.2	20.1	6.80	17500	329	2050	2300	137	107	691	1050	78.2	2520	2390	137		
	118	314.6	307.0	18.7	11.9	277.2	23.3	7.89	15000	277	1760	1960	136	90.2	588	893	77.5	1630	1980	118		
	96.8	308.0	305.0	15.4	9.9	277.2	28.0	9.58	12400	223	1450	1600	134	72.9	478	725	76.7	928	1560	96.8		
250 UC 89.5	260.0	256.0	17.3	10.5	14.0	225.4	21.5	7.10	11400	143	1100	1230	112	48.4	378	575	65.2	1040	713	250 UC 89.5		
	72.9	253.8	254.0	14.2	8.6	225.4	26.2	8.64	9320	114	897	992	111	38.8	306	463	64.5	586	557	72.9		
200 UC 59.5	209.8	205.0	14.2	9.3	11.4	181.4	19.5	6.89	7620	61.3	584	656	89.7	20.4	199	303	51.7	477	195	200 UC 59.5		
	52.2	206.4	204.0	12.5	8.0	181.4	22.7	7.84	6660	52.8	512	570	89.1	17.7	174	264	51.5	325	166	52.2		
	46.2	203.4	203.0	11.0	7.3	181.4	24.8	8.90	5900	45.9	451	500	88.2	15.3	151	230	51.0	228	142	46.2		
150 UC 37.2	161.8	154.0	11.5	8.1	8.9	138.8	17.1	6.34	4730	22.2	274	310	68.4	7.01	91.0	139	38.5	197	39.6	150 UC 37.2		
	30.0	157.6	153.0	9.4	6.6	138.8	21.0	7.79	3860	17.6	223	250	67.5	5.62	73.4	112	38.1	109	30.8	30.0		
	23.4	152.4	152.0	6.8	6.1	138.8	22.8	10.7	2980	12.6	166	184	65.1	3.98	52.4	80.2	36.6	50.2	21.1	23.4		
100 UC 14.8	97.0	99.0	7.0	5.0	10.0	83.0	16.6	6.71	1890	3.18	65.6	74.4	41.1	1.14	22.9	35.2	24.5	34.9	2.30	100 UC 14.8		



# Universal Columns

**Table 12 Universal Columns – Properties for Assessing Section Capacity**

Designation	Yield Stress		Form Factor	About x-axis		About y-axis		Designation
	Flange $f_y$	Web $f_y$		Compactness	$Z_{xx}$	Compactness	$Z_{yy}$	
	MPa	MPa		$10^3\text{mm}^3$		$10^3\text{mm}^3$		
<b>300PLUS® *</b>								
310 UC 158	280	300	1.00	C	2680	C	1210	310 UC 158
137	280	300	1.00	C	2300	C	1040	137
118	280	300	1.00	C	1960	C	882	118
96.8	300	320	1.00	N	1560	N	694	96.8
250 UC 89.5	280	320	1.00	C	1230	C	567	250 UC 89.5
72.9	300	320	1.00	N	986	N	454	72.9
200 UC 59.5	300	320	1.00	C	656	C	299	200 UC 59.5
52.2	300	320	1.00	C	570	C	260	52.2
46.2	300	320	1.00	N	494	N	223	46.2
150 UC 37.2	300	320	1.00	C	310	C	137	150 UC 37.2
30.0	320	320	1.00	C	250	C	110	30.0
23.4	320	320	1.00	N	176	N	73.5	23.4
100 UC 14.8	320	320	1.00	C	74.4	C	34.4	100 UC 14.8
<b>AS/NZS 3679.1-350</b>								
	MPa	MPa		$10^3\text{mm}^3$		$10^3\text{mm}^3$		
340	340	340	1.00	C	2680	C	1210	310 UC 158
340	340	340	1.00	C	2300	C	1040	137
340	340	340	1.00	N	1950	N	878	118
340	360	360	1.00	N	1550	N	684	96.8
340	360	360	1.00	C	1230	C	567	250 UC 89.5
340	360	360	1.00	N	977	N	448	72.9
340	360	360	1.00	C	656	C	299	200 UC 59.5
340	360	360	1.00	N	569	N	260	52.2
340	360	360	1.00	N	490	N	219	46.2
340	360	360	1.00	C	310	C	137	150 UC 37.2
360	360	360	1.00	N	248	N	109	30.0
360	360	360	1.00	N	174	N	72.3	23.4
360	360	360	1.00	C	74.4	C	34.4	100 UC 14.8

\* 300PLUS® replaced Grade 250 as the base grade for these sections in 1994.  
300PLUS® hot rolled sections are produced to exceed the minimum requirements of AS/NZS 3679.1-300.

**Notes**

1. For 300PLUS® sections the tensile strength ( $f_t$ ) is 440 MPa.
2. For Grade 350 sections the tensile strength ( $f_t$ ) is 480 MPa.
3. C: Compact Section; N: Non-compact Section; S: Slender Section.

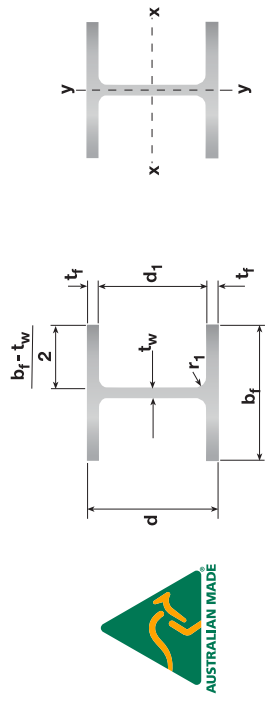

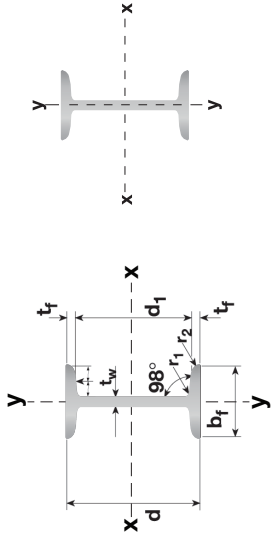

## Tapered Flange Beams

**Table 13 Tapered Flange Beams – Dimensions and Properties**

Designation	Mass per metre	Depth of Section	Flange Width	Web Thickness	Radii			Depth Between Flanges	Gross Area of Cross Section		About x-axis			About y-axis			Torsion Constant	Warping Constant	Designation			
					Root	Toe	Web		$d_1$	$(b_f - t_w)$	$A_g$	$I_x$	$Z_x$	$S_x$	$r_x$	$I_y$				$Z_y$	$S_y$	$r_y$
125 TFB	13.1	125	65.0	8.5	5.0	8.0	4.0	108	21.6	3.53	1670	4.34	80.3	80.3	50.9	10 <sup>6</sup> mm <sup>4</sup>	10 <sup>3</sup> mm <sup>3</sup>	10 <sup>3</sup> mm <sup>3</sup>	10 <sup>3</sup> mm <sup>6</sup>	40.2	1.14	125 TFB
100 TFB	7.20	100	45.0	6.0	4.0	7.0	3.0	88	22.0	3.42	917	1.46	29.2	34.1	39.9	0.0795	3.53	6.00	9.31	11.6	0.176	100 TFB

**Table 14 Tapered Flange Beams – Properties for Assessing Section Capacity**

Designation	Yield Stress			Form Factor	About x-axis			About y-axis			Designation	
	Flange $f_y$	Web $f_y$	MPa		Compactness	$Z_{ex}$	$Z_{ey}$	Compactness	$Z_{ex}$	$Z_{ey}$		Compactness
<b>300PLUS® *</b>												
125 TFB	320	320	320	1.00	C	80.3	15.6	C	80.3	15.6	C	125 TFB
100 TFB	320	320	320	1.00	C	34.1	5.30	C	34.1	5.30	C	100 TFB

\* 300PLUS® replaced Grade 250 as the base grade for these sections in 1997. 300PLUS® hot rolled sections are produced to exceed the minimum requirements of AS/NZS 3679.1-300.

### Notes

1. For 300PLUS® sections the tensile strength ( $f_{ty}$ ) is 430 MPa.
2. For Grade 350 sections the tensile strength ( $f_{ty}$ ) is 480 MPa.
3. C: Compact Section; N: Non-compact Section; S: Slender Section.

# Parallel Flange Channels

**Table 15 Parallel Flange Channels – Dimensions and Properties**

Designation	Mass per metre	Depth of Section	Flange		Web Thickness	Root Radius	Depth Between Flanges		Gross Area of Cross Section	Coordinate of Centroid		Coordinate of Shear Centre	About x-axis			About y-axis			Torsion Constant	Warping Constant	Designation						
			$b_f$	$t_f$			$t_w$	$r_1$		$d_1$	$d_2$		$d_1$	$t_w$	$t_f$	$A_g$	$X_c$	$X_o$				$I_x$	$Z_x$	$S_x$	$r_x$	$I_y$	$Z_y$
380 PFC	55.2	380	100	17.5	10.0	14.0	34.5	34.5	7030	27.5	56.7	mm	$10^6 \text{mm}^4$	$10^3 \text{mm}^3$	$10^3 \text{mm}^3$	152	798	946	147	6.48	89.4	236	161	30.4	491	$10^9 \text{mm}^6$	380 PFC
300 PFC	40.1	300	90	16.0	8.0	14.0	268	33.5	5110	27.2	56.1	mm	$10^6 \text{mm}^4$	$10^3 \text{mm}^3$	$10^3 \text{mm}^3$	72.4	483	564	119	4.04	64.4	148	117	28.1	304	$10^9 \text{mm}^6$	300 PFC
250 PFC	35.5	250	90	15.0	8.0	12.0	220	27.5	4520	28.6	58.5	mm	$10^6 \text{mm}^4$	$10^3 \text{mm}^3$	$10^3 \text{mm}^3$	45.1	361	421	99.9	3.64	59.3	127	107	28.4	248	$10^9 \text{mm}^6$	250 PFC
230 PFC	25.1	230	75	12.0	6.5	12.0	206	31.7	3200	22.6	46.7	mm	$10^6 \text{mm}^4$	$10^3 \text{mm}^3$	$10^3 \text{mm}^3$	26.8	233	271	91.4	1.76	33.6	77.8	61.0	23.5	112	$10^9 \text{mm}^6$	230 PFC
200 PFC	22.9	200	75	12.0	6.0	12.0	176	29.3	2920	24.4	50.5	mm	$10^6 \text{mm}^4$	$10^3 \text{mm}^3$	$10^3 \text{mm}^3$	19.1	191	221	80.9	1.65	32.7	67.8	58.9	23.8	105	$10^9 \text{mm}^6$	200 PFC
180 PFC	20.9	180	75	11.0	6.0	12.0	158	26.3	2660	24.5	50.3	mm	$10^6 \text{mm}^4$	$10^3 \text{mm}^3$	$10^3 \text{mm}^3$	14.1	157	182	72.9	1.51	29.9	61.5	53.8	23.8	84.5	$10^9 \text{mm}^6$	180 PFC
150 PFC	17.7	150	75	9.5	6.0	10.0	131	21.8	2250	24.9	51.0	mm	$10^6 \text{mm}^4$	$10^3 \text{mm}^3$	$10^3 \text{mm}^3$	8.34	111	129	60.8	1.29	25.7	51.6	46.0	23.9	56.6	$10^9 \text{mm}^6$	150 PFC
125 PFC	11.9	125	65	7.5	4.7	8.0	110	23.4	1520	21.8	45.0	mm	$10^6 \text{mm}^4$	$10^3 \text{mm}^3$	$10^3 \text{mm}^3$	3.97	63.5	73.0	51.1	0.658	15.2	30.2	27.2	20.8	23.8	$10^9 \text{mm}^6$	125 PFC
100 PFC	8.33	100	50	6.7	4.2	8.0	86.6	20.6	1060	16.7	33.9	mm	$10^6 \text{mm}^4$	$10^3 \text{mm}^3$	$10^3 \text{mm}^3$	1.74	34.7	40.3	40.4	0.267	8.01	16.0	14.4	15.9	13.6	$10^9 \text{mm}^6$	100 PFC
75 PFC	5.92	75	40	6.1	3.8	8.0	62.8	16.5	754	13.7	27.2	mm	$10^6 \text{mm}^4$	$10^3 \text{mm}^3$	$10^3 \text{mm}^3$	0.683	18.2	21.4	30.1	0.120	4.56	8.71	8.20	12.6	8.42	$10^9 \text{mm}^6$	75 PFC

**Table 16 Parallel Flange Channels – Properties for Assessing Section Capacity**

Designation	Yield Stress		Form Factor		About x-axis		About y-axis		Yield Stress		Form Factor		About x-axis		About y-axis		Designation
	Flange $f_y$	Web $f_y$	$k_f$	$k_w$	$Z_{ex}$	$Z_{ey}$	Load A $Z_{ey}$	Load B $Z_{ey}$	Flange $f_y$	Web $f_y$	$k_f$	$k_w$	$Z_{ex}$	$Z_{ey}$	Load A $Z_{ey}$	Load B $Z_{ey}$	
	MPa	MPa			$10^3 \text{mm}^3$	$10^3 \text{mm}^3$	$10^3 \text{mm}^3$	$10^3 \text{mm}^3$	MPa	MPa			$10^3 \text{mm}^3$	$10^3 \text{mm}^3$	$10^3 \text{mm}^3$	$10^3 \text{mm}^3$	
380 PFC	280	320	1.00	1.00	946	115	134	134	360	360	1.00	1.00	946	104	104	134	380 PFC
300 PFC	300	320	1.00	1.00	564	82.3	96.6	96.6	360	360	1.00	1.00	564	77.2	77.2	96.6	300 PFC
250 PFC	300	320	1.00	1.00	421	88.7	89.0	89.0	360	360	1.00	1.00	421	84.9	84.9	89.0	250 PFC
230 PFC	300	320	1.00	1.00	271	45.1	50.4	50.4	360	360	1.00	1.00	271	42.6	42.6	50.4	230 PFC
200 PFC	300	320	1.00	1.00	221	46.7	49.1	49.1	360	360	1.00	1.00	221	44.5	44.5	49.1	200 PFC
180 PFC	300	320	1.00	1.00	182	44.9	44.8	44.8	360	360	1.00	1.00	182	44.1	44.1	44.8	180 PFC
150 PFC	320	320	1.00	1.00	129	38.5	38.5	38.5	360	360	1.00	1.00	129	38.5	38.5	38.5	150 PFC
125 PFC	320	320	1.00	1.00	72.8	22.8	22.8	22.8	360	360	1.00	1.00	72.0	22.5	22.5	22.8	125 PFC
100 PFC	320	320	1.00	1.00	40.3	12.0	12.0	12.0	360	360	1.00	1.00	40.3	12.0	12.0	12.0	100 PFC
75 PFC	320	320	1.00	1.00	21.4	6.84	6.84	6.84	360	360	1.00	1.00	21.4	6.84	6.84	6.84	75 PFC

\* 300PLUS® replaced Grade 250 as the base grade for these sections in 1994.  
 300PLUS® hot rolled sections are produced to exceed the minimum requirements of AS/NZS 3679, 1-300.

**Notes**

1. For 300PLUS® sections the tensile strength ( $f_t$ ) is 440 MPa.
2. For Grade 350 sections the tensile strength ( $f_t$ ) is 480 MPa.
3. C: Compact Section; N: Non-compact Section; S: Slender Section.

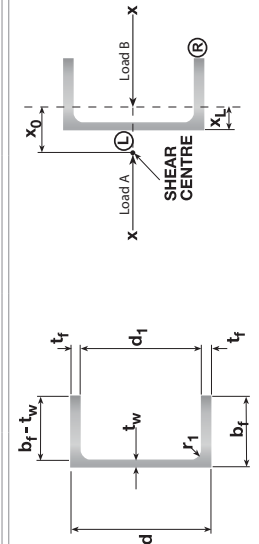

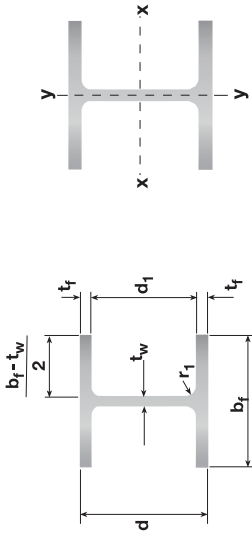

## Universal Bearing Piles (refer Note 4)

**Table 17 Universal Bearing Piles – Dimensions and Properties**

Designation	Depth of Section	Flange		Web		Root Radius	Depth Between Flanges	Gross Area of Cross Section	About x-axis			About y-axis			Torsion Constant	Warping Constant	Designation		
		Width	Thickness	Thickness	Thickness				$d_1$	$(b_f t_w)$	$A_g$	$I_x$	$Z_x$	$S_x$				$r_x$	$I_y$
kg/m	d	mm	$b_f$	$t_f$	$t_w$	$r_1$	$d_1$	$2t_f$	$I_x$	$Z_x$	$S_x$	$r_x$	$I_y$	$Z_y$	$S_y$	$r_y$	$J$	$I_w$	
310UBP149	318	316	20.6	20.5	20.5	16.5	277	7.14	19000	2080	2370	132	109	691	1070	75.8	2970	2410	310UBP 149
110	308	311	15.4	15.3	15.3	16.5	277	9.57	14000	1530	1720	130	76.6	494	759	73.9	1240	1640	110
78.8	299	306	11.1	11.1	11.1	16.5	277	13.3	10100	1100	1220	128	53.1	34.7	530	72.5	484	1100	78.8
200UBP122	230	220	25.0	25.0	25.0	11.4	180	3.90	15600	1120	1340	91.0	44.6	406	635	53.5	3540	469	200UBP 122

**Table 18 Universal Bearing Piles – Properties for Assessing Section Capacity**

Designation	Yield Stress		Form Factor		About x-axis		About y-axis		Yield Stress		Form Factor		About x-axis		About y-axis		Designation
	Flange $f_y$	Web $f_y$	$k_f$	Compactness	Compactness	$Z_{rx}$	Compactness	$Z_{ry}$	Flange $f_y$	Web $f_y$	$k_f$	Compactness	Compactness	$Z_{rx}$	$Z_{ry}$		
	MPa	MPa				$10^3 \text{mm}^3$		$10^3 \text{mm}^3$	MPa	MPa				$10^3 \text{mm}^3$	$10^3 \text{mm}^3$		
	<b>300PLUS® *</b>																
310 UB P 149	280	280	1.00	C	C	2370	C	1040	340	340	1.00	C	C	2370	1040	C	310 UB P 149
110	300	300	1.00	N	N	1680	N	718	340	340	1.00	N	N	1660	708	N	110
78.8	300	300	1.00	N	N	1130	N	460	340	340	1.00	N	N	1110	450	N	78.8
200 UB P 122	280	280	1.00	C	C	1340	C	609	340	340	1.00	C	C	1340	609	C	200 UB P 122

\* 300PLUS® hot rolled sections are produced to exceed the minimum requirements of AS/NZS 3679.1-300.

### Notes

1. For 300PLUS® sections the tensile strength ( $f_t$ ) is 440 MPa.
2. For Grade 350 sections the tensile strength ( $f_t$ ) is 480 MPa.
3. C: Compact Section; N: Non-compact Section; S: Slender Section.
4. These sections are generally not stocked and are available for project orders only subject to enquiry from your nearest Liberty Steel Sales Office.

# Equal Angles

**Table 19 Equal Angles – x-axis and y-axis – Dimensions and Properties**

Designation	Nominal Thickness	Mass per metre	Actual Thickness	Radii		Gross Area of Cross Section		Coordinate of Centroid		About x-axis					About y-axis					Torsion Constant	Designation							
				Root	Toe	(b <sub>1</sub> -t)	A <sub>g</sub>	P <sub>B</sub>	n <sub>c</sub>	n <sub>r</sub>	P <sub>r</sub>	I <sub>x</sub>	I <sub>y</sub>	x <sub>3</sub>	y <sub>4</sub>	Z <sub>x4</sub>	S <sub>x</sub>	r <sub>x</sub>	I <sub>y</sub>			x <sub>3</sub>	Z <sub>y3</sub>	S <sub>y</sub>	r <sub>y</sub>			
b <sub>1</sub> x b <sub>1</sub>	t	kg/m	mm	r <sub>1</sub>	r <sub>2</sub>	t	A <sub>g</sub>	P <sub>B</sub>	n <sub>c</sub>	n <sub>r</sub>	P <sub>r</sub>	I <sub>x</sub>	I <sub>y</sub>	x <sub>3</sub>	y <sub>4</sub>	Z <sub>x4</sub>	S <sub>x</sub>	r <sub>x</sub>	I <sub>y</sub>	x <sub>3</sub>	Z <sub>y3</sub>	S <sub>y</sub>	r <sub>y</sub>	J				
200 x 200 x 26 EA	26.0	76.8	26.0	18.0	5.0	6.69	9780	59.3	14.1	106	17.6	56.8	14.9	73.9	141	402	643	76.2	0.857	460	73.9	178	329	39.0	2250	200 x 200 x 26 EA		
20 EA	20.0	60.1	20.0	18.0	5.0	9.00	7660	57.0	14.3	106	15.1	45.7	11.8	72.9	141	323	511	77.2	0.695	391	80.6	147	260	39.3	1060	200 x 200 x 20 EA		
18 EA	18.0	54.4	18.0	18.0	5.0	10.1	6930	56.2	14.4	106	14.1	41.7	10.8	72.6	149	236	464	77.6	0.582	306	79.5	136	236	39.4	778	18 EA		
16 EA	16.0	48.7	16.0	18.0	5.0	11.5	6200	55.4	14.5	106	13.6	37.6	9.72	72.3	141	266	417	77.9	0.458	248	78.4	124	212	39.6	554	16 EA		
13 EA	13.0	40.0	13.0	18.0	5.0	14.4	5090	54.2	14.6	106	11.9	31.2	8.08	71.9	141	221	344	78.3	0.330	176	76.6	105	176	39.8	304	13 EA		
150 x 150 x 19 EA	19.0	42.1	19.0	13.0	5.0	6.89	5360	44.2	10.6	106	10.6	17.6	4.60	54.9	106	166	265	57.2	0.282	117	62.6	73.5	135	29.3	657	150 x 150 x 19 EA		
16 EA	15.8	35.4	15.8	13.0	5.0	8.49	4520	43.0	10.7	106	10.6	15.1	3.91	54.3	106	142	225	57.8	0.226	88.2	62.6	64.2	115	29.4	386	16 EA		
12 EA	12.0	27.3	12.0	13.0	5.0	11.5	3480	41.5	10.8	106	11.9	11.9	3.06	53.7	106	112	175	58.4	0.173	58.4	58.7	52.1	89.3	29.6	174	12 EA		
10 EA	10.0	22.5	10.0	13.0	5.0	14.8	2790	40.5	10.9	106	10.6	9.61	2.48	53.4	106	90.6	141	58.7	0.147	42.4	46.4	43.3	72.0	29.8	88.9	10 EA		
125 x 125 x 16 EA	29.1	15.8	12.0	10.0	5.0	6.91	3710	36.8	8.82	88.2	8.43	8.43	2.20	45.4	88.2	95.4	153	47.7	0.154	2.20	45.4	48.5	52.1	24.4	313	125 x 125 x 16 EA		
12 EA	22.5	12.0	10.0	10.0	5.0	9.42	2870	35.4	8.96	89.6	6.69	8.43	1.73	44.7	89.6	75.7	120	48.3	0.122	1.73	44.7	38.6	50.1	24.5	141	12 EA		
10 EA	18.0	9.5	10.0	10.0	5.0	12.2	2300	34.4	9.06	90.6	5.44	8.43	1.40	44.4	90.6	61.6	96.5	48.7	0.117	1.40	44.4	31.5	48.7	24.7	71.9	10 EA		
8 EA	14.9	7.8	10.0	10.0	5.0	15.0	1900	33.7	9.13	91.3	4.55	8.43	1.17	44.2	91.3	51.5	80.2	48.9	0.0959	1.17	44.2	26.5	47.7	24.5	40.6	8 EA		
100 x 100 x 12 EA	17.7	12.0	8.0	8.0	5.0	7.33	2260	29.2	7.08	70.8	3.29	7.07	0.857	35.8	70.8	46.6	74.5	38.2	0.0723	0.857	35.8	23.9	20.8	19.5	110	100 x 100 x 12 EA		
10 EA	14.2	9.5	8.0	8.0	5.0	9.53	1810	28.2	7.18	71.8	2.70	7.07	0.695	35.4	71.8	38.2	60.4	38.6	0.0571	0.695	35.4	19.6	30.7	19.6	56.2	10 EA		
8 EA	11.8	7.8	8.0	8.0	5.0	11.8	1500	27.5	7.25	72.5	2.27	7.07	0.582	35.2	72.5	32.0	50.3	38.8	0.0458	0.582	35.2	14.9	25.6	19.7	31.7	8 EA		
6 EA	9.16	6.0	8.0	8.0	5.0	15.7	1170	26.8	7.32	73.2	1.78	7.07	0.458	35.0	73.2	25.2	39.3	39.1	0.0330	0.458	35.0	13.1	20.0	19.8	14.8	6 EA		
90 x 90 x 10 EA	12.7	9.5	8.0	8.0	5.0	8.47	1620	25.7	6.43	64.3	1.93	6.36	0.500	31.9	64.3	30.4	48.3	34.5	0.0266	0.500	31.9	13.8	24.6	17.6	50.5	90 x 90 x 10 EA		
8 EA	10.6	7.8	8.0	8.0	5.0	10.5	1350	25.0	6.50	65.0	1.63	6.36	0.419	31.7	65.0	25.6	40.4	34.8	0.0212	0.419	31.7	13.2	20.5	17.6	28.6	8 EA		
6 EA	8.22	6.0	8.0	8.0	5.0	14.0	1050	24.3	6.57	65.7	1.28	6.36	0.330	31.5	65.7	20.1	31.6	35.0	0.0173	0.330	31.5	10.5	16.1	17.8	13.4	6 EA		
75 x 75 x 10 EA	10.5	9.5	8.0	8.0	5.0	6.89	1340	22.0	5.30	53.0	1.08	5.30	0.282	26.6	53.0	20.4	32.8	28.4	0.0147	0.282	26.6	10.6	16.8	14.5	41.9	75 x 75 x 10 EA		
8 EA	8.73	7.8	8.0	8.0	5.0	8.62	1110	21.3	5.37	53.7	0.913	5.30	0.237	26.4	53.7	17.2	27.5	28.7	0.0122	0.237	26.4	8.99	14.0	14.6	23.8	8 EA		
6 EA	6.81	6.0	8.0	8.0	5.0	11.5	867	20.5	5.45	54.5	0.722	5.30	0.187	26.2	54.5	13.6	21.6	28.9	0.00933	0.187	26.2	7.15	11.0	14.7	11.2	6 EA		
5 EA	5.27	4.6	8.0	8.0	5.0	15.3	672	19.9	5.51	55.1	0.563	5.30	0.147	26.1	55.1	10.6	16.7	29.0	0.00862	0.147	26.1	5.62	8.61	14.8	5.28	5 EA		
65 x 65 x 10 EA	9.02	9.5	6.0	6.0	3.0	5.84	1150	19.6	4.54	45.4	0.691	4.60	0.183	23.7	45.4	15.0	24.3	24.5	0.00723	0.183	23.7	7.71	6.60	12.5	35.1	65 x 65 x 10 EA		
8 EA	7.51	7.8	6.0	6.0	3.0	7.33	957	19.0	4.60	46.0	0.589	4.60	0.154	23.4	46.0	12.8	20.5	24.8	0.00675	0.154	23.4	6.56	5.73	10.5	20.0	8 EA		
6 EA	5.87	6.0	6.0	6.0	3.0	9.83	748	18.3	4.67	46.7	0.471	4.60	0.122	23.1	46.7	10.2	16.2	25.1	0.00536	0.122	23.1	5.26	4.71	8.25	12.8	6 EA		
5 EA	4.56	4.6	6.0	6.0	3.0	13.1	581	17.7	4.73	47.3	0.371	4.60	0.0959	23.0	47.3	8.08	12.7	25.3	0.00469	0.0959	23.0	4.18	25.0	3.83	6.46	5 EA		
55 x 55 x 6 EA	4.93	6.0	6.0	6.0	3.0	8.17	628	15.8	3.92	39.2	0.278	3.89	0.0723	19.6	39.2	7.14	11.4	21.0	0.00383	0.0723	19.6	3.69	3.24	5.82	10.7	7.93	55 x 55 x 6 EA	
5 EA	3.84	4.6	6.0	6.0	3.0	11.0	489	15.2	3.98	39.8	0.220	3.89	0.0571	19.4	39.8	5.66	8.93	21.2	0.00303	0.0571	19.4	2.94	2.15	4.57	10.8	3.71	5 EA	
50 x 50 x 8 EA	5.68	7.8	6.0	6.0	3.0	5.41	723	15.2	3.48	34.8	0.253	3.54	0.0675	18.1	34.8	7.16	11.7	18.7	0.00265	0.0675	18.1	3.73	2.15	6.00	15.2	5.0 x 50 x 8 EA		
6 EA	4.46	6.0	6.0	6.0	3.0	7.33	568	14.5	3.55	35.5	0.205	3.54	0.0536	17.8	35.5	5.79	9.30	19.0	0.00212	0.0536	17.8	3.01	2.05	4.76	9.71	7.21	6 EA	
5 EA	3.48	4.6	6.0	6.0	3.0	9.87	443	13.9	3.61	36.1	0.163	3.54	0.0424	17.6	36.1	4.61	7.32	19.2	0.00173	0.0424	17.6	2.40	1.97	3.75	9.78	3.38	5 EA	
3 EA	2.31	3.0	6.0	6.0	3.0	15.7	295	13.2	3.68	36.8	0.110	3.54	0.0289	17.6	36.8	3.11	4.90	19.3	0.00147	0.0289	17.6	1.65	1.55	2.53	9.90	1.01	3 EA	
45 x 45 x 6 EA	3.97	6.0	5.0	5.0	3.0	6.50	506	13.3	3.17	31.7	0.146	3.18	0.0383	16.0	31.7	4.59	7.41	17.0	0.00122	0.0383	16.0	2.39	1.88	2.04	3.79	6.32	45 x 45 x 6 EA	
5 EA	3.10	4.6	5.0	5.0	3.0	8.78	394	12.7	3.23	32.3	0.117	3.18	0.0303	15.8	32.3	3.66	5.84	17.2	0.00107	0.0303	15.8	1.91	1.68	2.99	2.96	5 EA		
3 EA	2.06	3.0	5.0	5.0	3.0	14.0	263	12.0	3.30	33.0	0.0790	3.18	0.0206	15.7	33.0	2.48	3.92	17.3	0.000862	0.0206	15.7	1.31	1.21	2.02	8.85	0.875	3 EA	
40 x 40 x 6 EA	3.50	6.0	5.0	5.0	3.0	5.67	446	12.0	2.80	28.0	0.0997	2.83	0.0265	14.3	28.0	3.53	5.75	15.0	0.000723	0.0265	14.3	1.86	1.70	1.55	2.95	7.71	5.60	40 x 40 x 6 EA
5 EA	2.73	4.6	5.0	5.0	3.0	7.70	348	11.5	2.85	28.5	0.0801	2.83	0.0209	14.0	28.5	2.83	4.55	15.2	0.000675	0.0209	14.0	1.49	1.29	2.33	7.75	2.63	5 EA	
3 EA	1.83	3.0	5.0	5.0	3.0	12.3	233	10.8	2.92	29.2	0.0545	2.83	0.0142	13.9	29.2	1.93	3.06	15.3	0.000606	0.0142	13.9	1.02	0.933	1.58	7.82	0.785	3 EA	
30 x 30 x 6 EA	2.56	6.0	5.0	5.0	3.0	4.00	326	9.53	2.05	20.5	0.0387	2.12	0.0107	10.7	20.5	1.83	3.06	10.9	0.000573	0.0107	10.7	0.993	0.790	1.59	5.72	4.16	30 x 30 x 6 EA	
5 EA	2.01																											

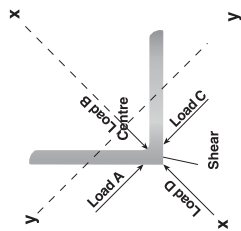

# Equal Angles

**Table 20 Equal Angles – x-axis and y-axis – Properties for Assessing Section Capacity**

Designation	Yield Stress			Form Factor	About x-axis			About y-axis			Designation
	$f_y$ MPa	$k_f$	Load A or C $Z_{ex}$ $10^3 \text{mm}^3$		Load B $Z_{ey}$ $10^3 \text{mm}^3$	Load D $Z_{ey}$ $10^3 \text{mm}^3$	Load A or C $Z_{ex}$ $10^3 \text{mm}^3$	Load B $Z_{ey}$ $10^3 \text{mm}^3$	Load D $Z_{ey}$ $10^3 \text{mm}^3$		
<b>300PLUS® *</b>											
200 x 200 x 26 EA	280	1.00	602	1.00	267	267	267	267	267	267	200 x 200 x 26 EA
20 EA	280	1.00	479	1.00	218	220	214	220	214	220	20 EA
18 EA	280	1.00	427	1.00	196	204	192	204	192	204	18 EA
16 EA	300	1.00	369	1.00	172	186	169	186	169	186	16 EA
13 EA	300	1.00	285	1.00	136	158	132	158	132	158	13 EA
150 x 150 x 19 EA	280	1.00	248	1.00	110	110	110	110	110	110	150 x 150 x 19 EA
16 EA	300	1.00	212	1.00	95.7	96.3	94.5	96.3	94.5	96.3	16 EA
12 EA	300	1.00	155	1.00	72.3	78.1	70.9	78.1	70.9	78.1	12 EA
10 EA	320	0.958	114	1.00	54.5	64.9	53.1	64.9	53.1	64.9	10 EA
125 x 125 x 16 EA	300	1.00	143	1.00	63.4	63.4	63.4	63.4	63.4	63.4	125 x 125 x 16 EA
12 EA	300	1.00	110	1.00	50.3	51.7	49.6	51.7	49.6	51.7	12 EA
10 EA	320	1.00	83.2	1.00	38.9	43.1	38.1	43.1	38.1	43.1	10 EA
8 EA	320	0.943	64.3	1.00	30.7	36.8	29.9	36.8	29.9	36.8	8 EA
100 x 100 x 12 EA	300	1.00	69.9	1.00	31.1	31.1	31.1	31.1	31.1	31.1	100 x 100 x 12 EA
10 EA	320	1.00	55.1	1.00	25.2	26.1	24.8	26.1	24.8	26.1	10 EA
8 EA	320	1.00	43.7	1.00	20.4	22.4	20.0	22.4	20.0	22.4	8 EA
6 EA	320	0.906	30.9	1.00	14.8	18.1	14.4	18.1	14.4	18.1	6 EA
90 x 90 x 10 EA	320	1.00	45.0	1.00	20.4	20.6	20.6	20.6	20.6	20.6	90 x 90 x 10 EA
8 EA	320	1.00	36.0	1.00	16.7	17.8	16.4	17.8	16.4	17.8	8 EA
6 EA	320	1.00	25.9	1.00	12.4	14.4	12.1	14.4	12.1	14.4	6 EA
75 x 75 x 10 EA	320	1.00	30.5	1.00	13.6	13.6	13.6	13.6	13.6	13.6	75 x 75 x 10 EA
8 EA	320	1.00	25.4	1.00	11.6	11.8	11.5	11.8	11.5	11.8	8 EA
6 EA	320	1.00	18.7	1.00	8.85	9.66	8.70	9.66	8.70	9.66	6 EA
5 EA	320	0.927	13.2	1.00	6.47	7.82	6.30	7.82	6.30	7.82	5 EA
65 x 65 x 10 EA	320	1.00	22.5	1.00	9.90	9.90	9.90	9.90	9.90	9.90	65 x 65 x 10 EA
8 EA	320	1.00	19.2	1.00	8.59	8.59	8.59	8.59	8.59	8.59	8 EA
6 EA	320	1.00	14.7	1.00	6.76	7.07	6.66	7.07	6.66	7.07	6 EA
5 EA	320	1.00	10.6	1.00	5.05	5.75	5.44	5.75	5.44	5.75	5 EA
55 x 55 x 6 EA	320	1.00	10.7	1.00	4.84	4.86	4.78	4.86	4.78	4.86	55 x 55 x 6 EA
5 EA	320	1.00	7.88	1.00	3.70	3.98	3.64	3.98	3.64	3.98	5 EA
50 x 50 x 8 EA	320	1.00	10.7	1.00	4.71	4.71	4.71	4.71	4.71	4.71	50 x 50 x 8 EA
6 EA	320	1.00	8.69	1.00	3.92	3.92	3.92	3.92	3.92	3.92	6 EA
5 EA	320	1.00	6.60	1.00	3.08	3.22	3.03	3.22	3.03	3.22	5 EA
3 EA	320	0.907	3.82	1.00	1.90	2.32	1.85	2.32	1.85	2.32	3 EA
45 x 45 x 6 EA	320	1.00	6.88	1.00	3.06	3.06	3.06	3.06	3.06	3.06	45 x 45 x 6 EA
5 EA	320	1.00	5.39	1.00	2.47	2.52	2.44	2.52	2.44	2.52	5 EA
3 EA	320	1.00	3.19	1.00	1.55	1.81	1.52	1.81	1.52	1.81	3 EA
40 x 40 x 6 EA	320	1.00	5.29	1.00	2.33	2.33	2.33	2.33	2.33	2.33	40 x 40 x 6 EA
5 EA	320	1.00	4.25	1.00	1.93	1.93	1.92	1.93	1.92	1.93	5 EA
3 EA	320	1.00	2.59	1.00	1.25	1.40	1.23	1.40	1.23	1.40	3 EA
30 x 30 x 6 EA	320	1.00	2.74	1.00	1.19	1.19	1.19	1.19	1.19	1.19	30 x 30 x 6 EA
5 EA	320	1.00	2.23	1.00	0.990	0.990	0.990	0.990	0.990	0.990	5 EA
3 EA	320	1.00	1.50	1.00	0.714	0.732	0.705	0.732	0.705	0.732	3 EA
25 x 25 x 6 EA	320	1.00	1.78	1.00	0.769	0.769	0.769	0.769	0.769	0.769	25 x 25 x 6 EA
5 EA	320	1.00	1.47	1.00	0.642	0.642	0.642	0.642	0.642	0.642	5 EA
3 EA	320	1.00	1.03	1.00	0.479	0.479	0.479	0.479	0.479	0.479	3 EA

**Notes**

1. For 300PLUS® sections the tensile strength (fu) is 440 MPa.
2. For Grade 350 sections the tensile strength (fu) is 480 MPa.

\* 300PLUS® replaced Grade 250 as the base grade for 125 x 125 x 8 equal angles and larger in 1994.  
 300PLUS® replaced Grade 250 as the base grade for 100 x 100 x 12 equal angles and smaller in 1997.  
 300PLUS® hot rolled sections are produced to exceed the minimum requirements of AS/NZS 3679:1-300.



# Equal Angles

Table 21 Equal Angles – n-axis and p-axis – Properties

Designation	About n-axis and p-axis						Product of 2nd Moment of Area		Designation
	$I_n = I_p$ $10^6 \text{mm}^4$	$I_n = P_B$ mm	$Z_{nb} = Z_{pL}$ $10^3 \text{mm}^3$	$r_n = P_T$ mm	$Z_{nt} = Z_{pR}$ $10^3 \text{mm}^3$	$S_n = S_p$ $10^3 \text{mm}^3$	$r_n = r_p$ mm	$I_{np}$ $10^6 \text{mm}^4$	
200 x 200 x 26 EA	358	593	605	141	255	460	605	200 x 200 x 26 EA	
20 EA	28.8	57.0	505	143	201	363	613	20 EA	
18 EA	26.3	56.2	467	144	183	330	615	18 EA	
16 EA	23.7	55.4	427	145	164	296	618	16 EA	
13 EA	19.7	54.2	363	146	135	243	622	13 EA	
150 x 150 x 19 EA	11.1	44.2	250	106	105	189	454	150 x 150 x 19 EA	
16 EA	9.48	43.0	220	107	88.7	160	458	16 EA	
12 EA	7.46	41.5	180	108	68.8	124	463	12 EA	
10 EA	6.04	40.5	149	109	55.2	99.9	466	10 EA	
125 x 125 x 16 EA	5.32	36.8	144	88.2	60.3	109	37.9	125 x 125 x 16 EA	
12 EA	4.21	35.4	119	89.6	47.0	85.0	38.3	12 EA	
10 EA	3.42	34.4	99.4	90.6	37.8	68.4	38.6	10 EA	
8 EA	2.86	33.7	84.9	91.3	31.3	56.8	38.8	8 EA	
100 x 100 x 12 EA	2.08	29.2	71.1	70.8	29.3	53.2	30.3	100 x 100 x 12 EA	
10 EA	1.70	28.2	60.1	71.8	23.6	42.9	30.6	10 EA	
8 EA	1.42	27.5	51.7	72.5	19.6	35.7	30.8	8 EA	
6 EA	1.12	26.8	41.8	73.2	15.3	27.8	31.0	6 EA	
90 x 90 x 10 EA	1.22	25.7	47.3	64.3	18.9	34.4	27.4	90 x 90 x 10 EA	
8 EA	1.02	25.0	40.9	65.0	15.7	28.7	27.6	8 EA	
6 EA	0.805	24.3	33.2	65.7	12.3	22.4	27.7	6 EA	
75 x 75 x 10 EA	0.681	22.0	31.0	53.0	12.8	23.4	22.6	75 x 75 x 10 EA	
8 EA	0.575	21.3	27.0	53.7	10.7	19.6	22.7	8 EA	
6 EA	0.455	20.5	22.1	54.5	8.35	15.3	22.9	6 EA	
5 EA	0.355	19.9	17.9	55.1	6.44	11.8	23.0	5 EA	
65 x 65 x 10 EA	0.437	19.6	22.3	45.4	9.62	17.4	19.5	65 x 65 x 10 EA	
8 EA	0.371	19.0	19.6	46.0	8.07	14.6	19.7	8 EA	
6 EA	0.296	18.3	16.2	46.7	6.34	11.5	19.9	6 EA	
5 EA	0.234	17.7	13.2	47.3	4.94	8.97	20.1	5 EA	
55 x 55 x 6 EA	0.175	15.8	11.1	39.2	4.46	8.11	16.7	55 x 55 x 6 EA	
5 EA	0.139	15.2	9.12	39.8	3.48	6.34	16.8	5 EA	
50 x 50 x 8 EA	0.160	15.2	10.5	34.8	4.61	8.38	14.9	50 x 50 x 8 EA	
6 EA	0.129	14.5	8.90	35.5	3.64	6.63	15.1	6 EA	
5 EA	0.103	13.9	7.36	36.1	2.85	5.19	15.2	5 EA	
3 EA	0.0694	13.2	5.25	36.8	1.89	3.46	15.3	3 EA	
45 x 45 x 6 EA	0.0922	13.3	6.93	31.7	2.91	5.30	13.5	45 x 45 x 6 EA	
5 EA	0.0734	12.7	5.76	32.3	2.28	4.16	13.6	5 EA	
3 EA	0.0498	12.0	4.14	33.0	1.51	2.77	13.8	3 EA	
40 x 40 x 6 EA	0.0631	12.0	5.24	28.0	2.26	4.12	11.9	40 x 40 x 6 EA	
5 EA	0.0505	11.5	4.39	28.5	1.77	3.24	12.0	5 EA	
3 EA	0.0344	10.8	3.19	29.2	1.18	2.17	12.2	3 EA	
30 x 30 x 6 EA	0.0247	9.53	2.59	20.5	1.21	2.22	8.71	30 x 30 x 6 EA	
5 EA	0.0200	8.99	2.22	21.0	0.951	1.76	8.83	5 EA	
3 EA	0.0138	8.30	1.66	21.7	0.635	1.18	8.93	3 EA	
25 x 25 x 6 EA	0.0135	8.28	1.63	16.7	0.807	1.49	7.13	25 x 25 x 6 EA	
5 EA	0.0110	7.75	1.42	17.3	0.638	1.19	7.23	5 EA	
3 EA	0.00765	7.07	1.08	17.9	0.426	0.802	7.33	3 EA	

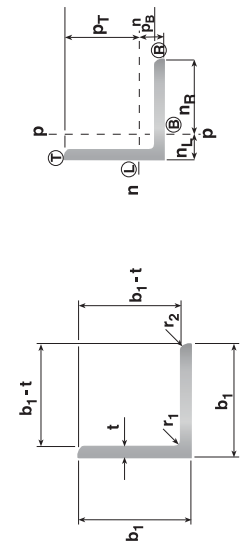

# Unequal Angles

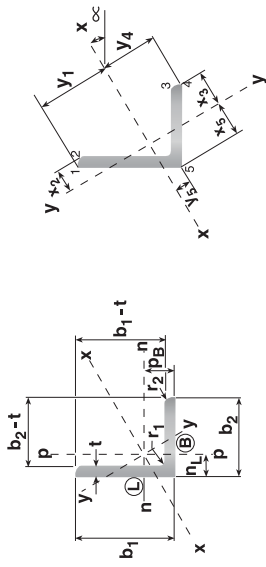

**Table 22 Unequal Angles – x-axis and y-axis – Dimensions and Properties**

Designation	Nominal Mass Thickness p/ metre	Actual Thickness	Radii	Gross Area of Cross Section	About x-axis					About y-axis					Torsion Constant	Tan Alpha	Designation												
					$A_g$	$I_x$	$Y_1$	$Z_{x1}$	$Y_4$	$Z_{x4}$	$Y_5$	$Z_{x5}$	$I_y$	$X_2$				$Z_{y2}$	$X_3$	$Z_{y3}$	$X_5$	$Z_{y5}$							
150 x 100 x 12 UA	22.5	12.0	100 5.0	11.5	7.33	2870	49.1	24.3	7.51	102	73.5	75.3	99.7	35.2	213	127	51.2	1.35	27.6	48.8	52.9	25.5	42.0	32.1	51.7	21.7	141	0.438	150 x 100 x 12 UA
10 UA	18.0	9.5	100 5.0	14.8	9.53	2300	48.1	23.3	6.11	103	59.5	74.9	81.5	34.6	177	102	51.6	1.09	26.9	40.7	53.0	20.6	40.7	26.9	41.8	21.8	71.9	0.441	10 UA
150 x 90 x 16 UA	27.9	15.8	100 5.0	8.49	4.70	3550	52.5	22.7	8.80	99.5	88.4	71.9	122	41.9	210	154	49.8	1.32	24.6	53.8	49.9	26.5	38.9	34.0	55.9	19.3	300	0.353	150 x 90 x 16 UA
12 UA	21.6	12.0	100 5.0	11.5	6.50	2750	51.0	21.2	6.97	100	69.4	71.3	97.8	40.8	171	120	50.4	1.04	23.4	44.5	50.1	20.8	37.2	28.0	43.8	19.5	136	0.360	12 UA
10 UA	17.3	9.5	100 5.0	14.8	8.47	2200	50.0	20.2	5.66	101	56.1	70.7	80.1	40.1	141	96.6	50.7	0.847	22.6	37.4	50.4	16.8	36.1	23.5	35.4	19.6	69.0	0.363	10 UA
8 UA	14.3	7.8	100 5.0	18.2	10.5	1820	49.2	19.6	4.73	101	46.7	70.3	67.3	39.5	120	80.1	51.0	0.710	22.1	32.2	50.6	14.0	35.2	20.2	29.5	19.7	39.0	0.364	8 UA
125 x 75 x 12 UA	17.7	12.0	80 5.0	9.42	5.25	2260	43.3	18.4	3.91	83.2	47.0	59.7	65.5	34.6	113	81.4	41.6	0.585	19.9	29.3	41.4	14.1	31.9	18.4	29.7	16.1	110	0.356	125 x 75 x 12 UA
10 UA	14.2	9.5	80 5.0	12.2	6.89	1810	42.3	17.5	3.20	83.8	38.2	59.3	53.9	33.9	94.4	65.8	42.0	0.476	19.2	24.9	41.6	11.4	30.7	15.5	24.1	16.2	56.2	0.360	10 UA
8 UA	11.8	7.8	80 5.0	15.0	8.62	1500	41.5	16.8	2.68	84.2	31.8	58.9	45.5	33.3	80.4	54.6	42.2	0.399	18.6	21.5	41.8	9.55	29.9	13.3	20.1	16.3	31.7	0.363	8 UA
6 UA	9.16	6.0	80 5.0	19.8	11.5	1170	40.7	16.0	2.10	84.7	24.8	58.5	36.0	32.8	64.1	42.4	42.5	0.315	18.0	17.5	42.1	7.47	29.0	10.8	15.7	16.4	14.8	0.364	6 UA
100 x 75 x 10 UA	12.4	9.5	80 5.0	9.53	6.89	1580	31.8	19.4	1.89	69.2	27.3	54.5	34.6	18.6	101	46.5	34.6	0.401	22.3	18.0	36.4	11.0	32.2	12.5	21.2	16.0	49.1	0.546	100 x 75 x 10 UA
8 UA	10.3	7.8	80 5.0	11.8	8.62	1310	31.1	18.7	1.59	69.4	22.9	54.3	29.2	18.2	87.0	38.7	34.8	0.337	21.8	15.4	36.4	9.26	31.3	10.7	17.8	16.0	27.8	0.549	8 UA
6 UA	7.98	6.0	80 5.0	15.7	11.5	1020	30.3	17.9	1.25	69.7	17.9	54.0	23.1	17.9	70.0	30.1	35.1	0.265	21.4	12.4	36.5	7.27	30.3	8.75	13.9	16.2	13.0	0.551	6 UA
75 x 50 x 8 UA	7.23	7.8	70 3.0	8.62	5.41	921	25.2	12.8	0.586	50.8	11.5	37.8	15.5	18.0	32.5	20.0	25.2	0.106	14.2	7.46	26.4	4.01	21.7	4.88	8.19	10.7	19.5	0.430	75 x 50 x 8 UA
6 UA	5.66	6.0	70 3.0	11.5	7.33	721	24.4	12.1	0.468	51.2	9.15	37.5	12.5	17.6	26.7	15.8	25.5	0.0842	13.6	6.17	26.5	3.18	20.8	4.04	6.48	10.8	9.21	0.435	6 UA
5 UA	4.40	4.6	70 3.0	15.3	9.87	560	23.8	11.5	0.370	51.5	7.17	37.2	9.93	17.2	21.5	12.3	25.7	0.0666	13.2	5.03	26.6	2.50	20.1	3.32	5.09	10.9	4.32	0.437	5 UA
65 x 50 x 8 UA	6.59	7.8	60 3.0	7.33	5.41	840	21.1	13.6	0.421	44.9	9.37	36.3	11.6	11.6	36.4	16.1	22.4	0.0936	15.6	6.00	23.9	3.91	22.3	4.20	7.49	10.6	17.6	0.570	65 x 50 x 8 UA
6 UA	5.16	6.0	60 3.0	9.83	7.33	658	20.4	12.9	0.338	45.2	7.48	36.1	9.35	11.2	30.2	12.7	22.7	0.0743	15.1	4.91	23.9	3.11	21.4	3.48	5.93	10.6	8.29	0.575	6 UA
5 UA	4.02	4.6	60 3.0	13.1	9.87	512	19.8	12.4	0.267	45.4	5.89	35.9	7.43	10.9	24.5	9.92	22.8	0.0587	14.8	3.97	23.9	2.46	20.6	2.85	4.66	10.7	3.87	0.577	5 UA

# Unequal Angles

**Table 23 Unequal Angles – x-axis and y-axis – Properties for Assessing Section Capacity**

Designation	Yield Stress $f_y$ MPa	Form Factor $k_f$	About x-axis			About y-axis			Yield Stress $f_y$ MPa	Form Factor $k_f$	About x-axis			About y-axis			Designation
			Load A $Z_{ex}$	Load C $Z_{ex}$	Load B $Z_{ey}$	Load D $Z_{ey}$	Load A $Z_{ex}$	Load C $Z_{ex}$			Load B $Z_{ey}$	Load D $Z_{ey}$	Load A $Z_{ex}$	Load C $Z_{ex}$	Load B $Z_{ey}$	Load D $Z_{ey}$	
<b>300PLUS® *</b>																	
150 x 100 x 12 UA	300	1.00	102	110	35.3	38.2	100	110	1.00	100	110	34.7	38.2	150 x 100 x 12 UA			
10 UA	320	0.975	74.8	81.7	26.0	30.9	73.0	78.9	0.943	73.0	78.9	25.3	30.9	10 UA			
150 x 90 x 16 UA	300	1.00	132	133	39.5	39.8	130	133	1.00	130	133	39.0	39.8	150 x 90 x 16 UA			
12 UA	300	1.00	96.3	104	28.8	31.1	94.6	104	1.00	94.6	104	28.3	31.1	12 UA			
10 UA	320	0.973	70.6	81.8	21.2	25.2	68.8	79.5	0.940	68.8	79.5	20.6	25.2	10 UA			
8 UA	320	0.863	53.1	60.3	15.9	21.0	51.2	57.9	0.836	51.2	57.9	15.4	21.0	8 UA			
125 x 75 x 12 UA	300	1.00	68.6	70.5	20.6	21.2	67.6	70.5	1.00	67.6	70.5	20.3	21.2	125 x 75 x 12 UA			
10 UA	320	1.00	51.6	57.2	15.5	17.2	50.6	57.2	1.00	50.6	57.2	15.2	17.2	10 UA			
8 UA	320	0.964	39.8	46.0	11.9	14.3	38.8	44.7	0.931	38.8	44.7	11.6	14.3	8 UA			
6 UA	320	0.824	26.8	30.1	8.07	11.2	25.8	28.7	0.799	25.8	28.7	7.75	11.2	6 UA			
100 x 75 x 10 UA	320	1.00	39.4	40.9	15.9	16.6	38.8	40.9	1.00	38.8	40.9	15.7	16.6	100 x 75 x 10 UA			
8 UA	320	1.00	31.2	33.1	12.6	13.9	30.6	32.1	1.00	30.6	32.1	12.4	13.9	8 UA			
6 UA	320	0.946	22.0	21.8	8.93	10.9	21.4	20.7	0.917	21.4	20.7	8.68	10.9	6 UA			
75 x 50 x 8 UA	320	1.00	17.0	17.3	5.93	6.02	16.8	17.3	1.00	16.8	17.3	5.85	6.02	75 x 50 x 8 UA			
6 UA	320	1.00	12.6	13.7	4.37	4.77	12.4	13.7	1.00	12.4	13.7	4.30	4.77	6 UA			
5 UA	320	0.956	8.89	9.65	3.10	3.75	8.66	9.30	0.926	8.66	9.30	3.02	3.75	5 UA			
65 x 50 x 8 UA	320	1.00	14.1	14.1	5.86	5.86	14.1	14.1	1.00	14.1	14.1	5.86	5.86	65 x 50 x 8 UA			
6 UA	320	1.00	10.7	11.2	4.46	4.67	10.6	11.2	1.00	10.6	11.2	4.40	4.67	6 UA			
5 UA	320	1.00	7.76	7.92	3.23	3.68	7.59	7.64	1.00	7.59	7.64	3.17	3.68	5 UA			

\* 300PLUS® replaced Grade 250 as the base grade for 150 x 90 x 8 unequal angles and larger in 1994.

300PLUS® replaced Grade 250 as the base grade for 125 x 75 x 12 unequal angles and smaller in 1997.

300PLUS® hot rolled sections are produced to exceed the minimum requirements of AS/NZS 3679.1:300.

### Notes

1. For 300PLUS® sections the tensile strength (fu) is 440 MPa.
2. For Grade 350 sections the tensile strength (fu) is 480 MPa.

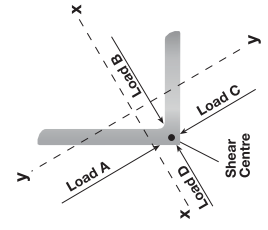

# Unequal Angles

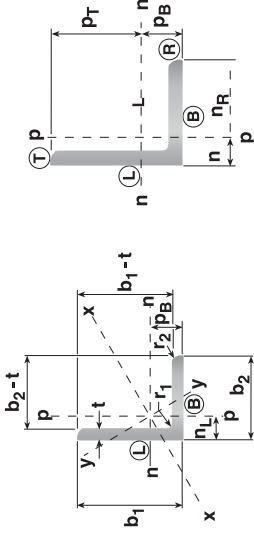
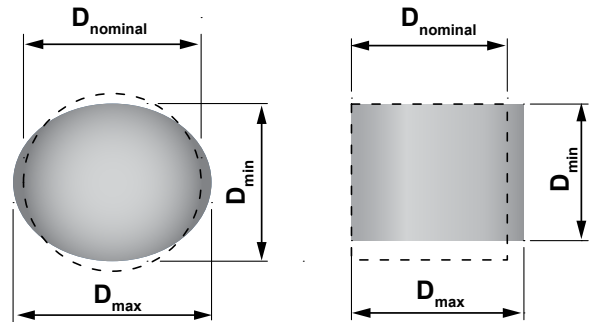

**Table 24 Unequal Angles – n-axis and p-axis – Dimensions and Properties**

Designation	About n-axis										About p-axis										Product of 2nd Moment of Area $I_{np}$	Designation
	$I_n$	$p_B$	$Z_{nB}$	$p_T$	$Z_{nT}$	$S_n$	$r_n$	$I_p$	$n_L$	$Z_{pL}$	$n_R$	$Z_{pR}$	$S_p$	$r_p$								
150 x 100 x 12 UA	6.52	49.1	133	101	64.6	117	47.7	2.34	24.3	96.2	75.7	30.9	56.0	28.6	-2.27	150 x 100 x 12 UA						
10 UA	5.29	48.1	110	102	51.9	94.0	48.0	1.91	23.3	81.9	76.7	24.9	44.7	28.8	-1.85	10 UA						
150 x 90 x 16 UA	7.97	52.5	152	97.5	81.7	145	47.4	2.15	22.7	94.9	67.3	32.0	59.5	24.6	-2.35	150 x 90 x 16 UA						
12 UA	6.29	51.0	123	99.0	63.5	114	47.8	1.72	21.2	81.0	68.8	25.0	45.7	25.0	-1.89	12 UA						
10 UA	5.10	50.0	102	100	51.0	91.5	48.2	1.41	20.2	69.5	69.8	20.2	36.5	25.3	-1.54	10 UA						
8 UA	4.26	49.2	86.6	101	42.3	76.0	48.4	1.18	19.6	60.4	70.4	16.8	30.1	25.5	-1.29	8 UA						
125 x 75 x 12 UA	3.54	43.3	81.8	81.7	43.3	77.3	39.6	0.958	18.4	52.0	56.6	16.9	31.4	20.6	-1.05	125 x 75 x 12 UA						
10 UA	2.88	42.3	68.2	82.7	34.9	62.5	39.9	0.789	17.5	45.2	57.5	13.7	25.1	20.9	-0.867	10 UA						
8 UA	2.41	41.5	58.1	83.5	28.9	52.0	40.1	0.664	16.8	39.6	58.2	11.4	20.7	21.0	-0.731	8 UA						
6 UA	1.89	40.7	46.5	84.3	22.5	40.6	40.3	0.524	16.0	32.7	59.0	8.89	16.0	21.2	-0.575	6 UA						
100 x 75 x 10 UA	1.55	31.8	48.6	68.2	22.6	41.3	31.3	0.743	19.4	38.3	55.6	13.4	24.3	21.7	-0.625	100 x 75 x 10 UA						
8 UA	1.30	31.1	41.8	68.9	18.8	34.4	31.5	0.626	18.7	33.5	56.3	11.1	20.2	21.9	-0.528	8 UA						
6 UA	1.02	30.3	33.7	69.7	14.6	26.9	31.7	0.494	17.9	27.5	57.1	8.67	15.7	22.0	-0.416	6 UA						
75 x 50 x 8 UA	0.511	25.2	20.3	49.8	10.3	18.5	23.6	0.181	12.8	14.1	37.2	4.86	8.96	14.0	-0.174	75 x 50 x 8 UA						
6 UA	0.407	24.4	16.7	50.6	8.05	14.6	23.8	0.145	12.1	12.0	37.9	3.84	6.98	14.2	-0.140	6 UA						
5 UA	0.321	23.8	13.5	51.2	6.27	11.4	23.9	0.115	11.5	10.0	38.5	3.00	5.41	14.3	-0.111	5 UA						
65 x 50 x 8 UA	0.341	21.1	16.2	43.9	7.75	14.1	20.1	0.174	13.6	12.7	36.4	4.78	8.74	14.4	-0.141	65 x 50 x 8 UA						
6 UA	0.272	20.4	13.4	44.6	6.10	11.1	20.3	0.140	12.9	10.8	37.1	3.77	6.85	14.6	-0.114	6 UA						
5 UA	0.215	19.8	10.9	45.2	4.75	8.70	20.5	0.111	12.4	8.96	37.6	2.95	5.32	14.7	-0.0903	5 UA						

## Rounds and Squares

Table 25 Permissible variations in cross-sectional dimensions for Rounds and Squares

Nominal Dimension	Permissible Variation	Permissible out-of-round or out-of-square
$D_{\text{nominal}}$		$D_{\text{max}} - D_{\text{min}}$
mm	mm	mm
$\leq 25$	$\pm 0.25$	0.40
$> 25 \leq 30$	$\pm 0.30$	0.45
$> 30 \leq 40$	$\pm 0.40$	0.60
$> 40 \leq 50$	$\pm 0.50$	0.75
$> 50 \leq 60$	$\pm 0.60$	0.90
$> 60 \leq 70$	$\pm 0.70$	1.05
$> 70 \leq 80$	$\pm 0.80$	1.20
$> 80 \leq 100$	$\pm 0.90$	1.35
$> 80^* \leq 100^*$	+2.45 to -0*	1.85*



Note: \* indicates alternative for material produced as primary-rolled product.

## Flats

Table 26 Permissible variations in cross-sectional dimensions for Flats

Nominal Width		Width Tolerance	Thickness Tolerance				
W			T				
mm		mm	mm				
			<6	$\geq 6 \leq 12$	$> 12 \leq 25$	$> 25 \leq 50$	>50
$\leq 25$		$\pm 0.40$	$\pm 0.20$	$\pm 0.20$	$\pm 0.25$	-	-
$> 25$	$\leq 50$	$\pm 0.80$	$\pm 0.20$	$\pm 0.30$	$\pm 0.40$	$\pm 0.80$	-
$> 50$	$\leq 100$	+1.60 to -0.80	$\pm 0.20$	$\pm 0.40$	$\pm 0.50$	$\pm 0.80$	$\pm 1.20$
$> 100$	$\leq 150$	+2.40 to -1.60	$\pm 0.25$	$\pm 0.40$	$\pm 0.50$	$\pm 0.80$	$\pm 1.60$

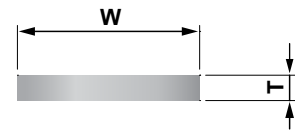

# Universal Beam

Table 27 Universal Beam Tolerances

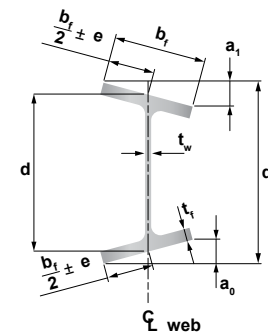
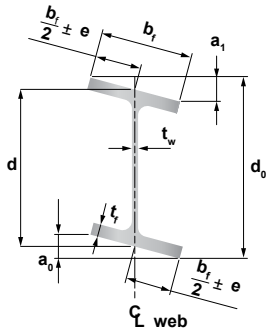

Designation	Permissible variation of depth	Permissible variation of flange width	Permissible variation of flange thickness	Permissible variation of web thickness	Maximum difference of flange over four flanges	Permissible out-of-square on each flange	Permissible total out-of-square	Permissible web off-centre	Permissible overall depth over specified depth
	d	bf	tf	tw	mm	(a1 or a0)	(a1 + a0)	e	(d0 - d)
610UB125	±3.0	+6.0 to -5.0	±1.5	±0.7	1.5	5.0	8.0	5.0	6.0
610UB113	±3.0	+6.0 to -5.0	±1.5	±0.7	1.5	5.0	8.0	5.0	6.0
610UB101	±3.0	+6.0 to -5.0	±1.0	±0.7	1.0	5.0	8.0	5.0	6.0
530UB92.4	±3.0	+6.0 to -5.0	±1.5	±0.7	1.5	5.0	8.0	5.0	6.0
530UB82.0	±3.0	+6.0 to -5.0	±1.0	±0.7	1.0	5.0	8.0	5.0	6.0
460UB82.1	±3.0	+6.0 to -5.0	±1.5	±0.7	1.5	5.0	8.0	5.0	6.0
460UB74.6	±3.0	+6.0 to -5.0	±1.0	±0.7	1.0	5.0	8.0	5.0	6.0
460UB67.1	±3.0	+6.0 to -5.0	±1.0	±0.7	1.0	5.0	8.0	5.0	6.0
410UB59.7	±3.0	+6.0 to -5.0	±1.0	±0.7	1.0	5.0	8.0	5.0	6.0
410UB53.7	±3.0	+6.0 to -5.0	±1.0	±0.7	1.0	5.0	8.0	5.0	6.0
360UB56.7	±3.0	+6.0 to -5.0	±1.0	±0.7	1.0	5.0	8.0	5.0	6.0
360UB50.7	±3.0	+6.0 to -5.0	±1.0	±0.7	1.0	5.0	8.0	5.0	6.0
360UB44.7	±3.0	+6.0 to -5.0	±1.0	±0.7	1.0	5.0	8.0	5.0	6.0
310UB46.2	±3.0	+6.0 to -5.0	±1.0	±0.7	1.0	5.0	8.0	5.0	6.0
310UB40.4	±3.0	+6.0 to -5.0	±1.0	±0.7	1.0	5.0	8.0	5.0	6.0
310UB32.0	±3.0	+6.0 to -5.0	±1.0	±0.7	1.0	5.0	8.0	5.0	6.0
250UB37.3	±3.0	+6.0 to -5.0	±1.0	±0.7	1.0	4.0	6.0	5.0	6.0
250UB31.4	±3.0	+6.0 to -5.0	±1.0	±0.7	1.0	4.0	6.0	5.0	6.0
250UB25.7	±3.0	+6.0 to -5.0	±1.0	±0.7	1.0	4.0	6.0	5.0	6.0
200UB29.8	±3.0	+6.0 to -5.0	±1.0	±0.7	1.0	4.0	6.0	5.0	6.0
200UB25.4	±3.0	+6.0 to -5.0	±1.0	±0.7	1.0	4.0	6.0	5.0	6.0
200UB22.3	±3.0	+6.0 to -5.0	±1.0	±0.7	1.0	4.0	6.0	5.0	6.0
200UB18.2	±3.0	+6.0 to -5.0	±1.0	±0.7	1.0	4.0	6.0	5.0	6.0
180UB22.2	+2.5 to -1.5	±3.0	±1.0	±0.7	1.0	2.0	2.5	2.5	4.0
180UB18.1	+2.5 to -1.5	±3.0	±1.0	±0.7	1.0	2.0	2.5	2.5	4.0
180UB16.1	+2.5 to -1.5	±3.0	±1.0	±0.7	1.0	2.0	2.5	2.5	4.0
150UB18.0	+2.5 to -1.5	±3.0	±1.0	±0.7	1.0	1.5	2.5	2.5	4.0
150UB14.0	+2.5 to -1.5	±3.0	±1.0	±0.7	1.0	1.5	2.5	2.5	4.0

# Universal Column

Table 28 Universal Column Tolerances

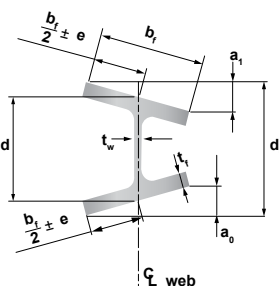
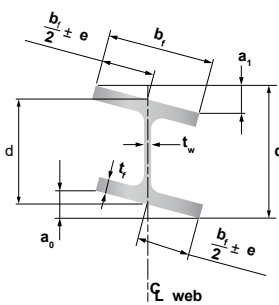

Designation	Permissible variation of depth	Permissible variation of flange width	Permissible variation of flange thickness	Permissible variation of web thickness	Maximum difference of flange over four flanges	Permissible out-of-square on each flange	Permissible total out-of-square	Permissible web off-centre	Permissible overall depth over specified depth
	d	bf	tf	tw	mm	(a1 or a0)	(a1 + a0)	e	(d0 - d)
310UC158	±3.0	+6.0 to -5.0	±1.5	±1.0	1.5	5.0	8.0	5.0	6.0
310UC137	±3.0	+6.0 to -5.0	±1.5	±0.7	1.5	5.0	8.0	5.0	6.0
310UC118	±3.0	+6.0 to -5.0	±1.5	±0.7	1.5	5.0	8.0	5.0	6.0
310UC96.8	±3.0	+6.0 to -5.0	±1.5	±0.7	1.5	5.0	8.0	5.0	6.0
250UC89.5	±3.0	+6.0 to -5.0	±1.5	±0.7	1.5	4.0	6.0	5.0	6.0
250UC72.9	±3.0	+6.0 to -5.0	±1.0	±0.7	1.0	4.0	6.0	5.0	6.0
200UC59.5	±3.0	+6.0 to -5.0	±1.0	±0.7	1.0	4.0	6.0	5.0	6.0
200UC52.2	±3.0	+6.0 to -5.0	±1.0	±0.7	1.0	4.0	6.0	5.0	6.0
200UC46.2	±3.0	+6.0 to -5.0	±1.0	±0.7	1.0	4.0	6.0	5.0	6.0
150UC37.2	±3.0	+6.0 to -5.0	±1.0	±0.7	1.0	4.0	6.0	5.0	6.0
150UC30.0	±3.0	+6.0 to -5.0	±1.0	±0.7	1.0	4.0	6.0	5.0	6.0
150UC23.4	±3.0	+6.0 to -5.0	±1.0	±0.7	1.0	4.0	6.0	5.0	6.0
100UC14.8	±3.0	+6.0 to -5.0	±1.0	±0.7	1.0	4.0	6.0	5.0	6.0



## Parallel Flange Channels

Table 29 Parallel Flange Channel Tolerances

	Permissible variation of depth	Permissible variation of flange width	Permissible variation of flange thickness	Permissible variation of web thickness	Permissible out-of-square on each flange	Permissible total out-of-square
	$d$	$b_f$	$t_f$	$t_w$	$(a_1 \text{ or } a_0)$	$(a_1 + a_0)$
Designation	mm	mm	mm	mm	mm	mm
380PFC	+5.0 to -3.0	+3.0 to -4.0	±1.0	±1.0	2.0	3.0
300PFC	+3.0 to -1.5	±3.0	±1.0	±1.0	1.5	2.7
250PFC	+3.0 to -1.5	±3.0	±1.0	±1.0	1.5	2.7
230PFC	+3.0 to -1.5	±3.0	±1.0	±1.0	1.5	2.3
200PFC	+3.0 to -1.5	±3.0	±1.0	±1.0	1.5	2.3
180PFC	+3.0 to -1.5	±3.0	±1.0	±1.0	1.5	2.3
150PFC	+3.0 to -1.5	±3.0	±1.0	±1.0	1.5	2.3
125PFC	+3.0 to -1.5	±3.0	±1.0	±1.0	1.5	2.0
100PFC	+3.0 to -1.5	±3.0	±0.7	±0.7	1.0	1.5
75PFC	+3.0 to -1.5	±3.0	±0.7	±0.7	1.0	1.2

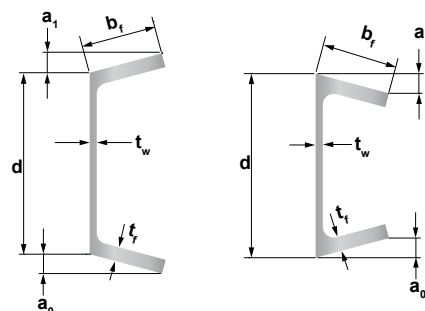

## Tapered Flange Beam

Table 30 Tapered Flange Beam Tolerances

	Permissible variation of depth	Permissible variation of flange width	Permissible variation of flange thickness	Permissible variation of web thickness	Permissible out-of-square on each flange	Permissible total out-of-square
	$d$	$b_f$	$t_f$	$t_w$	$(a_1 \text{ or } a_0)$	$(a_1 + a_0)$
Designation	mm	mm	mm	mm	mm	mm
125TFB	+2.5 to -1.5	±3.0	±0.7	±0.7	1.5	2.0
100TFB	+2.5 to -1.5	±3.0	±0.7	±0.7	1.5	1.4

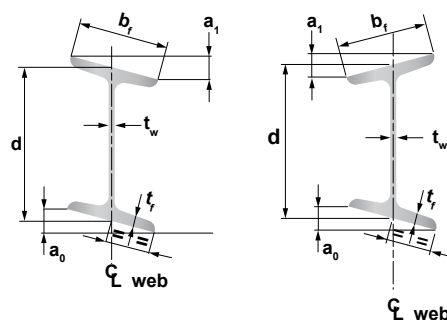

## Universal Bearing Piles

Table 31 Universal Bearing Pile Tolerances

	Permissible variation of depth	Permissible variation of flange width	Permissible variation of flange thickness	Permissible variation of web thickness	Maximum difference of flange over four flanges	Permissible out-of-square on each flange	Permissible total out-of-square	Permissible web off-centre	Permissible overall depth over specified depth
	$d$	$b_f$	$t_f$	$t_w$		$(a_1 \text{ or } a_0)$	$(a_1 + a_0)$	$e$	$(d_0 - d)$
Designation	mm	mm	mm	mm	mm	mm	mm	mm	mm
310UBP149	+3.0 to -2.0	±4.0	±1.5	±0.7	1.5	4.0	6.3	3.5	6.0
310UBP110	+3.0 to -2.0	±4.0	±1.5	±0.7	1.5	4.0	6.2	3.5	6.0
310UBP78.8	+3.5 to -3.5	+6.5 to -5.4	±1.0	±0.7	1.0	5.0	8.0	5.0	6.0
200UBP122	+3.4 to -3.4	+6.5 to -5.4	±1.5	±1.0	1.5	4.0	6.0	5.0	6.0

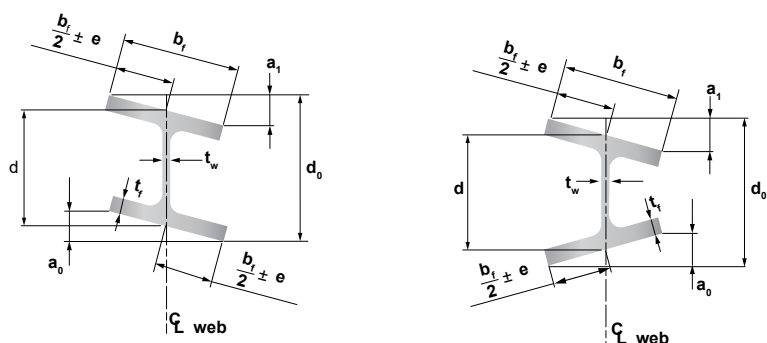

# Tolerances

## Equal Angle

Table 32 Equal Angle Tolerances

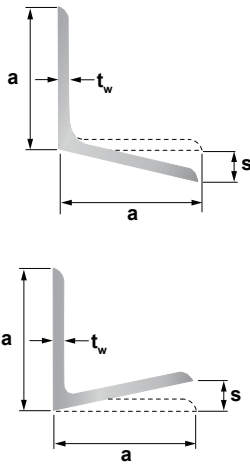

Designation	Permissible variation of leg length	Permissible variation of thickness	Permissible out-of-square
	<b>a</b>	<b>t<sub>w</sub></b>	<b>s</b>
	<b>mm</b>	<b>mm</b>	<b>mm</b>
200x200x26 EA	+5.0 to -3.0	±1.5	±5.0
200x200x20 EA	+5.0 to -3.0	±1.0	±5.0
200x200x18 EA	+5.0 to -3.0	±1.0	±5.0
200x200x16 EA	+5.0 to -3.0	±1.0	±5.0
200x200x13 EA	+5.0 to -3.0	±0.7	±5.0
150x150x19 EA	±3.0	±1.0	±4.0
150x150x16 EA	±3.0	±1.0	±4.0
150x150x12 EA	±3.0	±0.7	±4.0
150x150x10 EA	±3.0	±0.5	±4.0
125x125x16 EA	±3.0	±1.0	±3.0
125x125x12 EA	±3.0	±0.7	±3.0
125x125x10 EA	±3.0	±0.5	±3.0
125x125x8 EA	±3.0	±0.5	±3.0
100x100x12 EA	±3.0	±0.7	±3.0
100x100x10 EA	±3.0	±0.5	±3.0
100x100x8 EA	±3.0	±0.5	±3.0
100x100x6 EA	±3.0	±0.5	±3.0
90x90x10 EA	±3.0	±0.5	±3.0
90x90x8 EA	±3.0	±0.5	±3.0
90x90x6 EA	±3.0	±0.5	±3.0
75x75x10 EA	+2.5 to -1.5	±0.5	±2.0
75x75x8 EA	+2.5 to -1.5	±0.5	±2.0
75x75x6 EA	+2.5 to -1.5	±0.5	±2.0
75x75x5 EA	+2.5 to -1.5	±0.5	±2.0
65x65x10 EA	+2.5 to -1.5	±0.5	±2.0
65x65x8 EA	+2.5 to -1.5	±0.5	±2.0
65x65x6 EA	+2.5 to -1.5	±0.5	±2.0
65x65x5 EA	+2.5 to -1.5	±0.5	±2.0
55x55x6 EA	+2.5 to -1.5	±0.5	±2.0
55x55x5 EA	+2.5 to -1.5	±0.5	±2.0
50x50x8 EA	+2.5 to -1.5	±0.5	±2.0
50x50x6 EA	+2.5 to -1.5	±0.5	±2.0
50x50x5 EA	+2.5 to -1.5	±0.5	±2.0
50x50x3 EA	+2.5 to -1.5	±0.5	±2.0
45x45x6 EA	+2.5 to -1.5	±0.5	±2.0
45x45x5 EA	+2.5 to -1.5	±0.5	±2.0
45x45x3 EA	+2.5 to -1.5	±0.5	±2.0
40x40x6 EA	+2.5 to -1.5	±0.5	±1.0
40x40x5 EA	+2.5 to -1.5	±0.5	±1.0
40x40x3 EA	+2.5 to -1.5	±0.5	±1.0
30x30x6 EA	+2.5 to -1.5	±0.5	±1.0
30x30x5 EA	+2.5 to -1.5	±0.5	±1.0
30x30x3 EA	+2.5 to -1.5	±0.5	±1.0
25x25x6 EA	+2.5 to -1.5	±0.5	±1.0
25x25x5 EA	+2.5 to -1.5	±0.5	±1.0
25x25x3 EA	+2.5 to -1.5	±0.5	±1.0

## Unequal Angle

Table 33 Unequal Angle Tolerances

Designation	Permissible variation of leg length – Long Leg	Permissible variation of leg length – Short Leg	Permissible variation of thickness	Permissible out-of-square
	a	b	$t_w$	s
	mm		mm	mm
150x100x12 UA	±3.0	±3.0	±0.7	±4.0
150x100x10 UA	±3.0	±3.0	±0.5	±4.0
150x90x16 UA	±3.0	±3.0	±1.0	±4.0
150x90x12 UA	±3.0	±3.0	±0.7	±4.0
150x90x10 UA	±3.0	±3.0	±0.5	±4.0
150x90x8 UA	±3.0	±3.0	±0.5	±4.0
125x75x12 UA	±3.0	+2.5 to –1.5	±0.7	±3.0
125x75x10 UA	±3.0	+2.5 to –1.5	±0.5	±3.0
125x75x8 UA	±3.0	+2.5 to –1.5	±0.5	±3.0
125x75x6 UA	±3.0	+2.5 to –1.5	±0.5	±3.0
100x75x10 UA	±3.0	+2.5 to –1.5	±0.5	±3.0
100x75x8 UA	±3.0	+2.5 to –1.5	±0.5	±3.0
100x75x6 UA	±3.0	+2.5 to –1.5	±0.5	±3.0
75x50x8 UA	+2.5 to –1.5	+2.5 to –1.5	±0.5	±2.0
75x50x6 UA	+2.5 to –1.5	+2.5 to –1.5	±0.5	±2.0
75x50x5 UA	+2.5 to –1.5	+2.5 to –1.5	±0.5	±2.0
65x50x8 UA	+2.5 to –1.5	+2.5 to –1.5	±0.5	±2.0
65x50x6 UA	+2.5 to –1.5	+2.5 to –1.5	±0.5	±2.0
65x50x5 UA	+2.5 to –1.5	+2.5 to –1.5	±0.5	±2.0

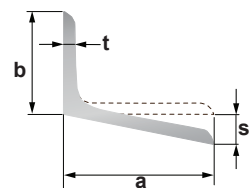
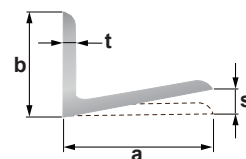

# Straightness

## Universal Sections

Table 34 Permissible Variations in Straightness for Universal Sections

Section	Camber (mm)	Sweep (mm)
Beams with flange $b_f < 150\text{mm}$	$\frac{\text{Length (mm)}}{1000}$	$\frac{\text{Length (mm)}}{500}$
Beams with flange $b_f \geq 150\text{mm}$	$\frac{\text{Length (mm)}}{1000}$	(See Note 2)
Columns $\leq 14000\text{mm}$ long	$\frac{\text{Length (mm)}}{1000}$ but no more than 10mm	(See Note 2)
Columns $> 14000\text{mm}$ long	$10\text{mm} + \frac{\text{Length (mm)} - 14000}{10000}$	(See Note 2)

**Notes:**

1. Measuring of the camber and sweep shall be in accordance with the figure below.
2. Owing to the extreme variation in the elastic flexibility of these sections about the y axis, difficulty may be experienced in obtaining reproducible sweep measurements.

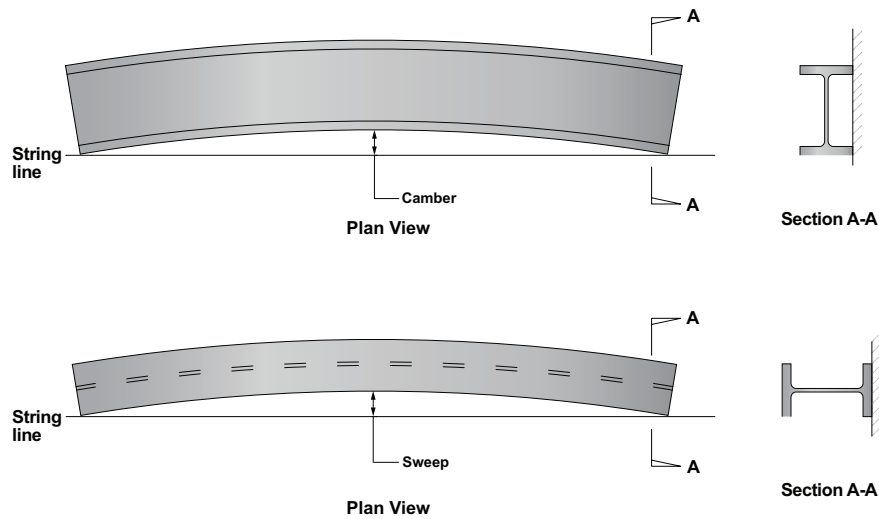

## Non-universal Sections

Table 35 Permissible Variations in Straightness for Channels, Taper Flange Beams and Angles

Section	Camber (mm)	Sweep (mm)
Channels	$\frac{\text{Length (mm)}}{500}$	(See Note 2)
Taper Flange Beams		
Angles		

**Notes:**

1. For angles having a combined leg length of greater than 150mm this is the straightness tolerance.
2. Owing to the extreme variation in flexibility of these sections about the y axis, straightness tolerances are as specified by the purchaser for the individual sections involved.

# Standard Specifications

## Structural Steel – Hot Rolled Bars and Sections – Standard: AS/NZS 3679.1

**Table 36 Chemical Composition – Bars and Sections**

Grade (see Note 1)	Cast analysis (max.) (See Notes 2 and 3)							
	%							
	C	Si	Mn	P	S	B	Micro-alloying elements (see Note 4)	CE (see Note 5)
300PLUS®, 300PLUS®L0, 300PLUS®L15, 300PLUS®S0	0.25	0.50	1.60	0.040	0.040	<0.0008	(see Note 6)	0.44
350, 350L0, 350L15, 350S0	0.22	0.50	1.60	0.040	0.040	<0.0008	(see Note 7)	0.45

**Notes**

- The use of sulfide modification steel making techniques for these grades is permitted.
- Grain refining elements, i.e. aluminium and titanium, may be added, provided that the total content does not exceed 0.15%. Limits are for total or soluble aluminium.
- The following elements may be present to the limits stated, subject to a maximum total of 1.00%:
 

(a) Copper	0.50%
(b) Nickel	0.50%
(c) Chromium	0.30%
(d) Molybdenum	0.10%
- For grade 300PLUS, the following are not considered as micro-alloying elements:
 

(a) Titanium	0.040% maximum
(b) Niobium	0.020% maximum
(c) Vanadium	0.030% maximum
(d) Niobium plus vanadium	0.030% maximum
- Carbon equivalent (CE) is calculated from the following equation:  

$$CE = C + \frac{Mn}{6} + \frac{Cr}{5} + \frac{Mo}{5} + \frac{V}{15} + \frac{Ni}{15} + \frac{Cu}{15}$$
- Micro-alloying elements are not permitted in grade 300 except for thicknesses greater than or equal to 15mm, where the following apply:
  - the maximum combined micro-alloying element content is 0.15%
  - where micro-alloying elements are used, the percentage of each element is to be shown on certificates.
- For grade 350, micro-alloying elements niobium, vanadium and titanium may be added, provided that their total combined content does not exceed 0.15%.

**Table 37 Tensile Properties – Flat Bars and Sections – Standard: AS/NZS 3679.1**

Grade	Minimum yield stress, MPa Thickness (see Note 1) mm			Minimum tensile strength MPa	Minimum elongation on a gauge length of $5.65\sqrt{S_0}$ % (see Note 2)
	< 11	≥ 11 to ≤ 17	> 17 to < 40		
300PLUS®, 300PLUS®L0, 300PLUS®L15	320	300	280	440	22
350, 350L0, 350L15	360	340	340	480	20

**Table 38 Tensile Properties – Round and Square Bars – Standard: AS/NZS 3679.1**

Grade	Minimum yield stress, MPa Thickness mm			Minimum tensile strength MPa	Minimum elongation on a gauge length of $5.65\sqrt{S_0}$ %
	≤ 50	> 50 to < 100	≥ 100		
300PLUS®	300	290	280	440	22
350	340	330	320	480	20

**Notes (apply to tables 37 and 38)**

- For a section, the term 'thickness' refers to the nominal thickness of the part from which the sample is taken.
- $S_0$  is the cross-sectional area of the test piece before testing.
- For precise details of properties reference should be made to the latest edition of AS/NZS 3679.1 or the latest Liberty Steel specification.
- 300PLUS® steel is produced to exceed the latest requirements for grade 300 in AS/NZS 3679.1.

**Table 39 Charpy V-Notch Impact Test Requirements – Bars and Sections – Standard: AS/NZS 3679.1**

Grade	Minimum Absorbed Energy, J Size of Test Piece						
	Test Temperature °C	10mm x 10mm		10mm x 7.5mm		10mm x 5mm	
		Average of 3 Tests	Individual Test	Average of 3 Tests	Individual Test	Average of 3 Tests	Individual Test
300PLUS®L0, 350L0*	0	27	20	22	16	18	13
300PLUS®L15, 350L15	-15	27	20	22	16	18	13

**Notes**

- This does not cover impact tested grades for thickness less than 7mm.  
 \*Impact testing is not available for bars and is only available for some sections by enquiry.

# Standard Specifications

## Merchant Bar Sections

Table 40 Chemical Composition – For Liberty Steel Merchant Bar Sections – Regular Grades – AS 1442

Steel Type	Grade	C		Si		Mn		P		S	
		Min.	Max.	Min.	Max.	Min.	Max.	Min.	Max.	Min.	Max.
Carbon and Carbon Manganese Steels	1016	0.13	0.18	0.10	0.35	0.60	0.90	*	0.040	*	0.040
	1022	0.18	0.23	0.10	0.35	0.70	1.00	*	0.040	*	0.040
	1045	0.43	0.50	0.10	0.35	0.60	0.90	*	0.040	*	0.040

Table 41 Chemical Composition – For Liberty Steel Merchant Bar Sections – Regular Grades – AS 1447

Steel Type	Grade	C		Si		Mn		P		S		Cr	
		Min.	Max.	Min.	Max.	Min.	Max.	Min.	Max.	Min.	Max.	Min.	Max.
Spring Steels	5160	0.55	0.65	0.10	0.35	0.70	1.00	*	0.040	*	0.040	0.70	0.90
	9258	0.50	0.65	1.60	2.20	0.70	1.05	*	0.040	*	0.040	*	*
	9261	0.55	0.65	1.80	2.20	0.70	1.00	*	0.040	*	0.040	0.10	0.25

Table 42 Liberty Steel Grades

Steel Type	Grade	C		Si		Mn		P		S		Cr		V	
		Min.	Max.	Min.	Max.	Min.	Max.	Min.	Max.	Min.	Max.	Min.	Max.	Min.	Max.
Liberty Steel	X4K92M61S*	0.55	0.65	1.60	1.90	0.70	1.00	*	0.040	*	0.040	0.10	0.25	0.15	0.25

Table 43 Heat Treatment Limitations

Maximum Recommended Cross Section*			
Grade	Rounds	Squares	Flats
5160	40mm	36mm	28mm
9261	27mm	25mm	19mm
9258			16mm

\* The recommendations are based on the criterion that, at the maximum dimensions, a hardness of 50 HRC can be achieved in the centre of the quenched section.

The actual properties obtained are dependent on both grade and heat treatment process control. As Liberty Steel has no control over the springmakers' heat treatment process, the above recommendations cannot be guaranteed. However, springmakers with efficient heat treatment facilities will be able to achieve a hardness value of 50 HRC as recommended.



# Customer Technical Service

## MORE INFORMATION

Further information on Liberty Steel products, services and other publications can be found at: [www.libertyfg.com](http://www.libertyfg.com)

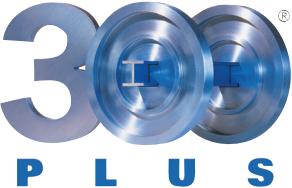



[www.libertygfg.com](http://www.libertygfg.com)

This publication has been prepared by Liberty OneSteel (Manufacturing) Pty Limited ABN 38 623 194 070. Please note that any specifications or technical data referred to in this publication are subject to change and/or variation or improvement without notice and no warranty as to their suitability for any use is made. Users of this publication, to ensure accuracy and adequacy for their purposes, are requested to check the information provided in this publication to satisfy themselves as to its appropriateness and not to rely on the information without first doing so. Unless required by law, the company cannot accept any responsibility for any loss, damage or consequence resulting from the use of this publication. Photographs shown are representative only of typical applications, current at November 2019. This brochure is not an offer to trade and shall not form any part of the trading terms in any transaction.

© Copyright 2019 Liberty OneSteel (Manufacturing) Pty Limited. 300PLUS® is a registered trademark of Liberty OneSteel (Manufacturing) Pty Limited ABN 38 623 194 070. Issue 9, November 2019.